



# User Guide



N.C. Punt  
December 2013

Title	Edsim++ user guide
Author	N.C. Punt
Revision	1.04
Date	17-12-2013
Status	4 <sup>rd</sup> revision

## DOCUMENT HISTORY

Revision	Date	Author	Description
1.00	30-05-2013	N.C. Punt	First print
1.01	13-06-2013	N.C. Punt	First revision
1.02	16-09-2013	N.C. Punt	Corrected header
1.03	17-12-2013	N.C. Punt	Fitting
1.04	18-12-2013	N.C. Punt	Parameter conversion

# TABLE OF CONTENTS

<b>1</b>	<b>INTRODUCTION.....</b>	<b>5</b>
1.1	DOCUMENT PURPOSE.....	5
1.2	DOCUMENTS SCOPE.....	5
1.3	EDSIM++ MISSION.....	5
<b>2</b>	<b>INSTALLATION.....</b>	<b>6</b>
2.1	SYSTEM REQUIREMENTS.....	6
2.2	INSTALLATION FOLDER.....	6
2.3	INSTALLATION PROCEDURE.....	6
2.4	INSTALL LICENSE.....	9
<b>3</b>	<b>QUICK START.....</b>	<b>10</b>
3.1	LAUNCH EDSIM++.....	10
3.2	OPEN A MODEL.....	10
3.3	SIMULATE A MODEL.....	11
3.4	MODIFY A MODEL.....	14
3.5	DECORATE A MODEL.....	15
<b>4</b>	<b>EDSIM++ DESKTOP.....</b>	<b>16</b>
4.1	OVERVIEW.....	16
4.2	ADDING OBJECTS.....	17
4.3	MANIPULATING OBJECTS.....	17
4.4	CONNECTING OBJECTS.....	17
4.5	SELECTING MULTIPLE OBJECTS.....	19
4.6	DUPLICATING AND DELETING SELECTED OBJECTS.....	19
4.7	OBJECT NAME & TYPE.....	19
4.8	OBJECT PROPERTIES.....	20
4.9	TOOLBAR BUTTONS.....	21
4.10	MENU ITEMS.....	21
4.11	ERROR MESSAGES.....	23
4.11.1	<i>Model Build Error Messages.....</i>	23
4.11.2	<i>Data Entry Error Messages.....</i>	23
<b>5</b>	<b>EDSIM++ MODELS.....</b>	<b>24</b>
5.1	MODEL STRUCTURE.....	24
5.2	OBJECT CATEGORIES.....	24
5.3	SYMBOL CATEGORIES.....	25
5.4	EDITING MODEL PROPERTIES.....	25
5.4.1	<i>[Obj]: Object Tab.....</i>	25
5.4.2	<i>[Var]: Variables Tab.....</i>	26
5.4.3	<i>[Par]: Parameters Tab.....</i>	27
5.4.4	<i>[Con]: Constants Tab.....</i>	28
5.4.5	<i>[Opt]: Options Tab.....</i>	28
5.4.6	<i>[Ext]: Externals Tab.....</i>	28
5.4.7	<i>[Cor]: Correlations Tab.....</i>	29
5.4.8	<i>[Obs]: Observations Tab.....</i>	30
5.4.9	<i>[Fit]: Fitting Tab.....</i>	30
5.4.10	<i>[Sim]: Simulation Tab.....</i>	31
5.4.11	<i>[App]: Application Tab.....</i>	33
<b>6</b>	<b>BUILDING MODELS.....</b>	<b>34</b>
6.1	ONE-COMPARTMENT MODEL.....	34
6.2	TWO-COMPARTMENT MODEL.....	36
6.3	AREA UNDER THE CURVE (AUC).....	36
6.4	TIME ABOVE LEVEL.....	37
6.5	EFFECT.....	38

---

<b>7</b>	<b>RESULTS VIEWER.....</b>	<b>39</b>
7.1	MICROSOFT EXCEL COMPATIBLE WORKBOOK.....	39
7.2	WORKBOOK DESIGNER MODE .....	40
7.3	DUAL MONITOR SUPPORT .....	40
<b>8</b>	<b>MODELS STORAGE.....</b>	<b>42</b>
8.1	FILE FORMATS .....	42
8.2	FORMAT SELECTION.....	42
8.3	EXCEL EXPORT .....	43
<b>9</b>	<b>SPECIAL SIMULATIONS .....</b>	<b>44</b>
9.1	VARIABLE ERROR .....	44
9.2	PARAMETER SENSITIVITY .....	45
9.2.1	<i>Confidence Interval</i> .....	45
<b>10</b>	<b>FITTING MODELS TO OBSERVATIONS .....</b>	<b>47</b>
10.1	BUILDING A MODEL.....	47
10.2	ADDING OBSERVATIONS .....	47
10.3	SELECTING PARAMETERS.....	48
10.4	ADJUST SETTINGS .....	48
10.5	PRE-SIMULATION.....	48
10.6	FITTING .....	49
10.7	FIT REPORT .....	49
10.8	SCALING AND WEIGHTING .....	51
<b>11</b>	<b>PARAMETER CONVERSION .....</b>	<b>52</b>
11.1	TEST MODEL.....	52
11.2	UNIT CONVERSION .....	53
11.3	SCALER CONVERSION .....	53
11.4	MODE CONVERSION .....	54
<b>12</b>	<b>EDSIM++ PLUG-INS .....</b>	<b>57</b>
12.1	MONTE CARLO SIMULATOR .....	57
12.2	DOSE CALCULATOR .....	57
<b>13</b>	<b>PROGRAMMING EDSIM++.....</b>	<b>58</b>
13.1	MACROS.....	58
13.2	OBJECTS.....	59
<b>14</b>	<b>APPENDICES .....</b>	<b>60</b>
14.1	EDSIM++ ERROR MESSAGES .....	60
14.2	FITTING METHODOLOGY .....	61



## 1 INTRODUCTION

### 1.1 Document Purpose

This document is the Edsim++ user guide. It shows the user how to design and run basic PKPD models using Edsim++. Advanced modeling examples are given in the accompanying video tutorials (<http://www.mediware.cz>).

### 1.2 Documents Scope

This document is limited to describing the basic operations in Edsim++. It does not represent an advanced PKPD modeling instruction.

### 1.3 Edsim++ Mission

Edsim++ is an object oriented visual pharmacokinetic-pharmacodynamic modeling tool for use in education and research. Edsim++ discriminates itself from other PKPD modeling software for the following reasons:

- Edsim++ is not a universal modeling tool that can be used in multiple application domains.
- Instead, Edsim++ focusses on PKPD modeling applications.
- This clear unambiguous choice resulted in a very easy to use, yet powerful, application.
- Edsim++ can be used for a broad range of PKPD modeling problems
- The Edsim++ PKPD object library can be extended by the end user (library).
- The Edsim++ application can be extended by programmers (plug-ins).
- Edsim++ is very suitable for use in research and education.

## 2 Installation

### 2.1 System Requirements

Edsim++ requires the Microsoft.NET framework version 4.0 to be installed on your system. You can download this package at [www.microsoft.com/download](http://www.microsoft.com/download).

### 2.2 Installation Folder

You can install Edsim++ on any folder on your system. This can also be a USB memory stick.

### 2.3 Installation Procedure

Double-click the Edsim++ setup program. The setup language selection dialog will appear.

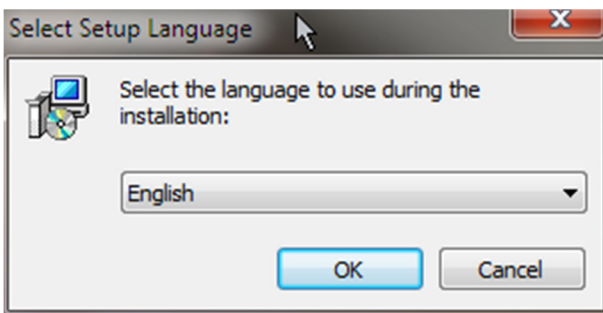

Select the language and click OK.

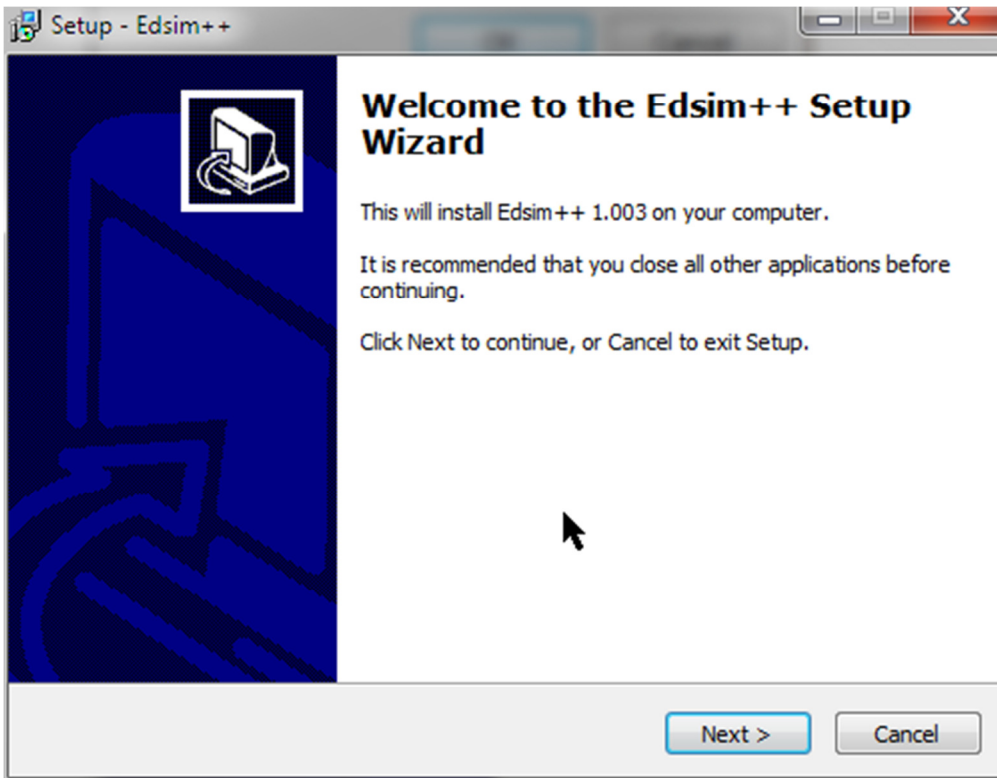

Click Next to continue.

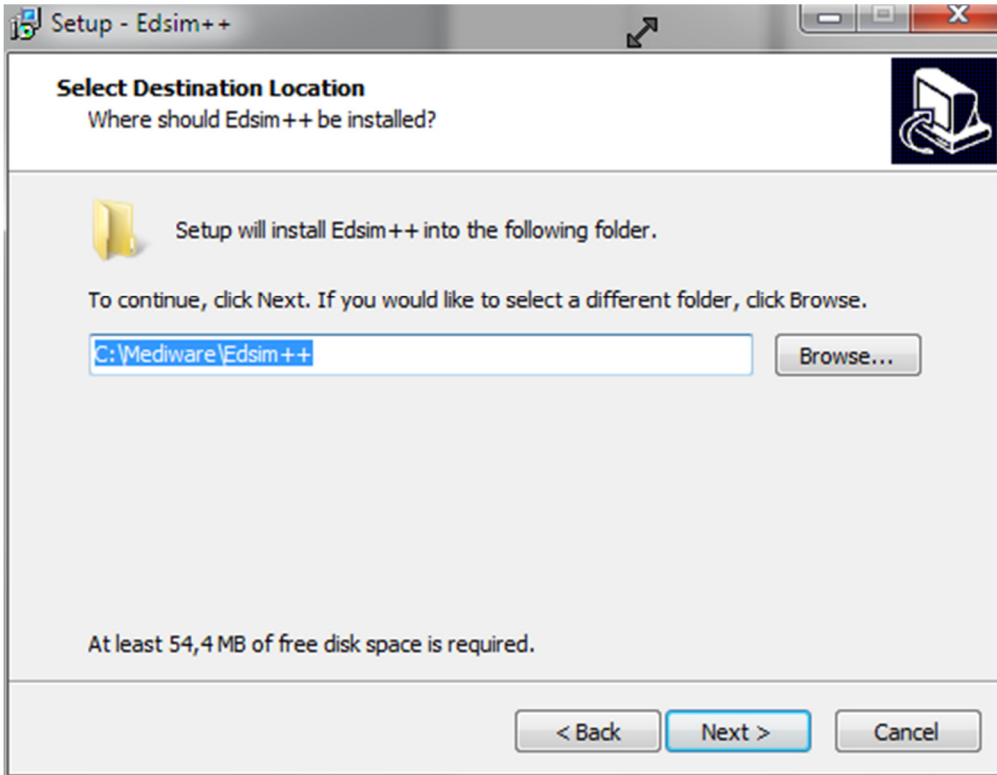

Specify the destination location and click Next.

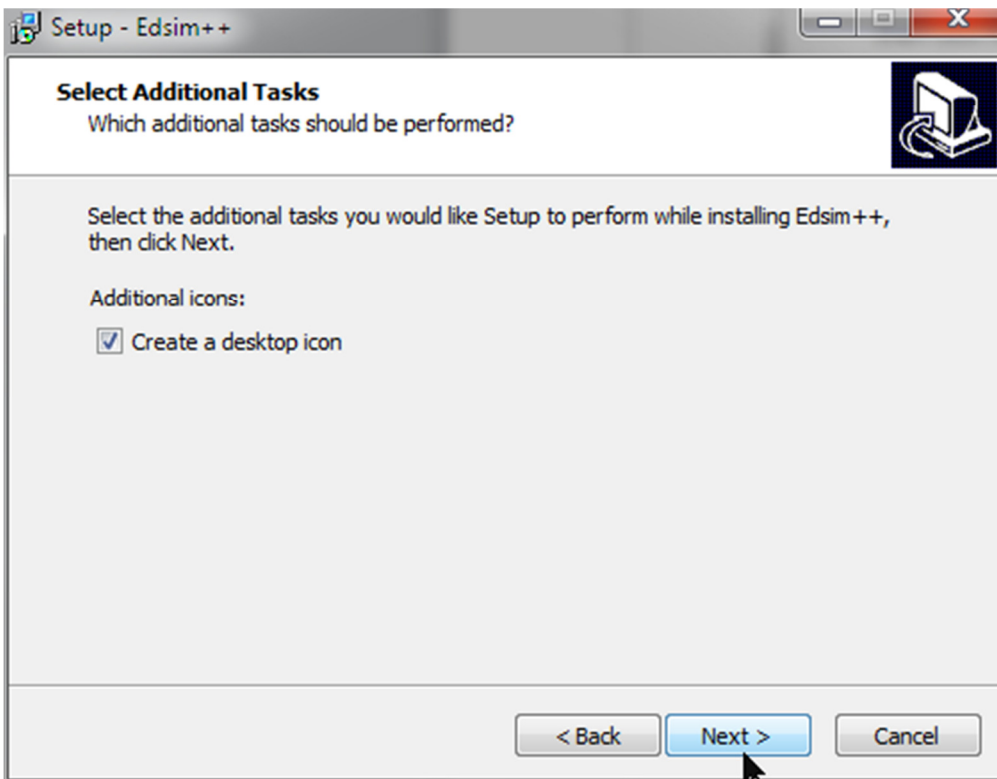

Specify if you want to have a desktop icon (recommended) and click Next.

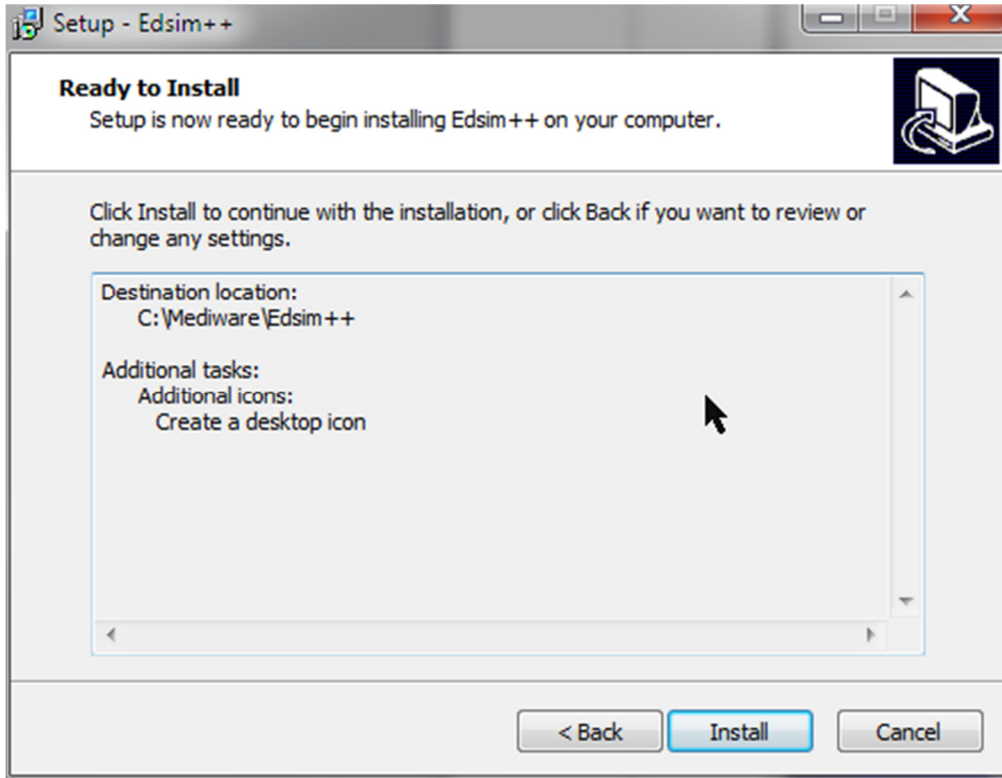

Review your installation settings. Click Back to modify these or click Install to continue.

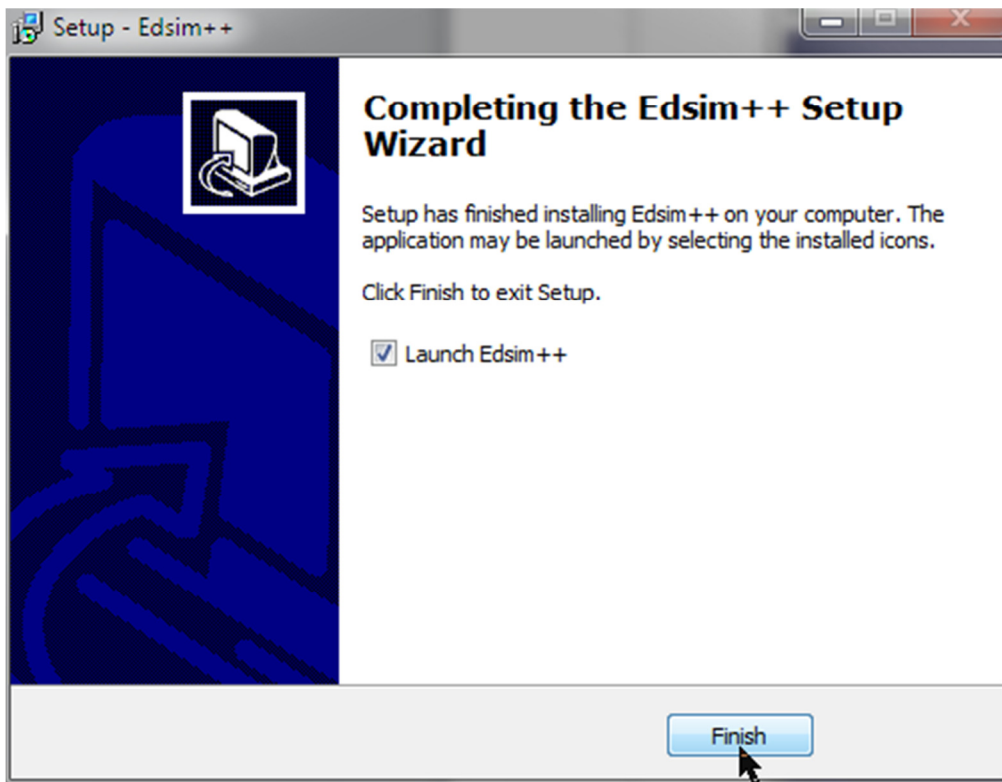

You can directly launch Edsim++ after the installation has been completed.

2.4 Install License

Edsim++ will stop working after a 30 days trial period. You must purchase a license in order to continue using Edsim++. The Edsim++ about screen is automatically shown when the trial period has expired.

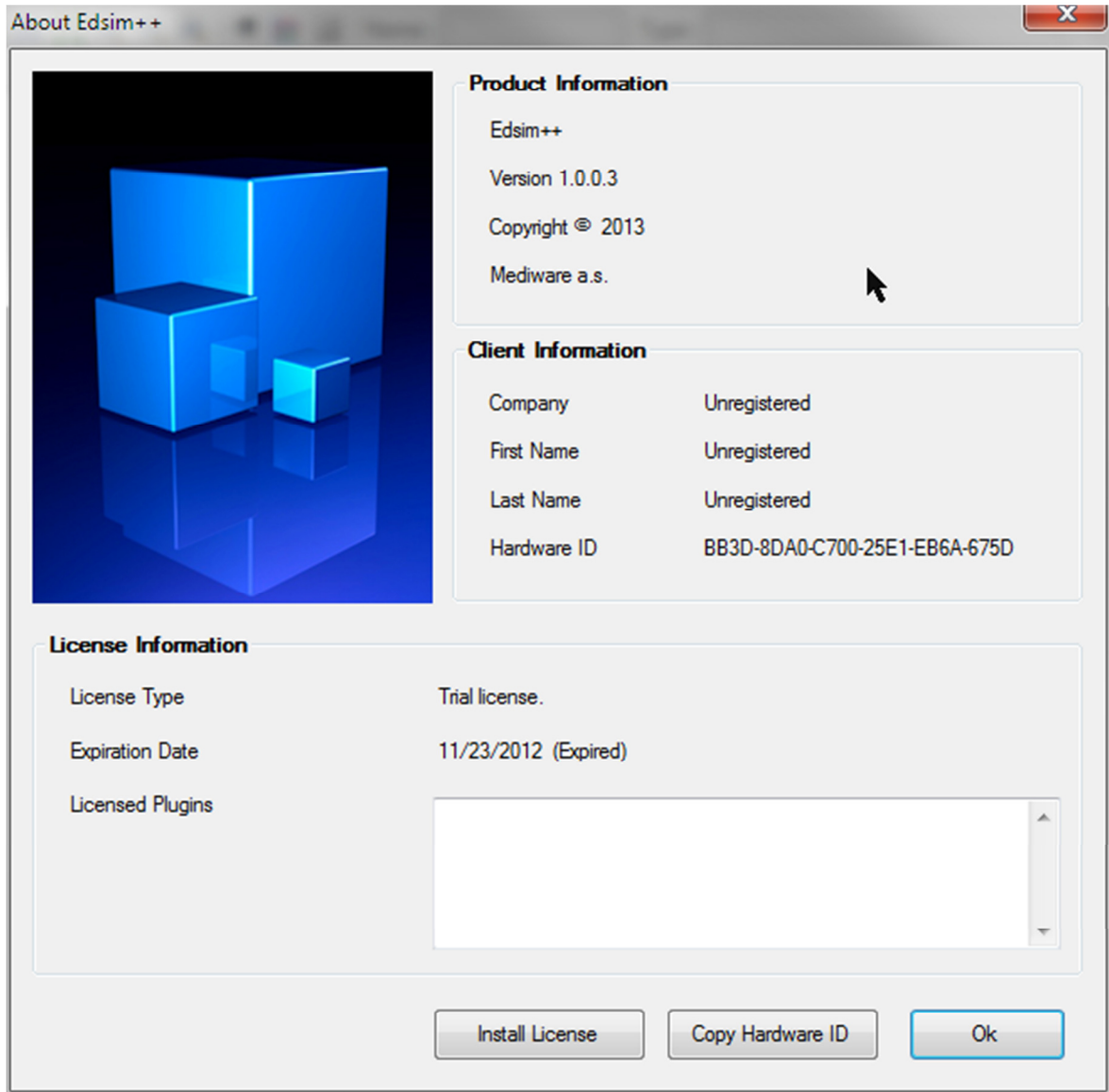

Email the displayed Hardware ID to the vendor. Simply click Copy Hardware ID and paste it into your email program. The license file will be send to you by email as an attachment. Save this attachment to disk and click the Install License button in Edsim++. Select the license file and click Open. Now you will have a licensed copy of Edsim++ so that you can continue using it.

### 3 QUICK START

#### 3.1 Launch Edsim++

Double-click on the Edsim++ icon on the windows desktop in order to start the application.



Edsim++

The application window will appear.

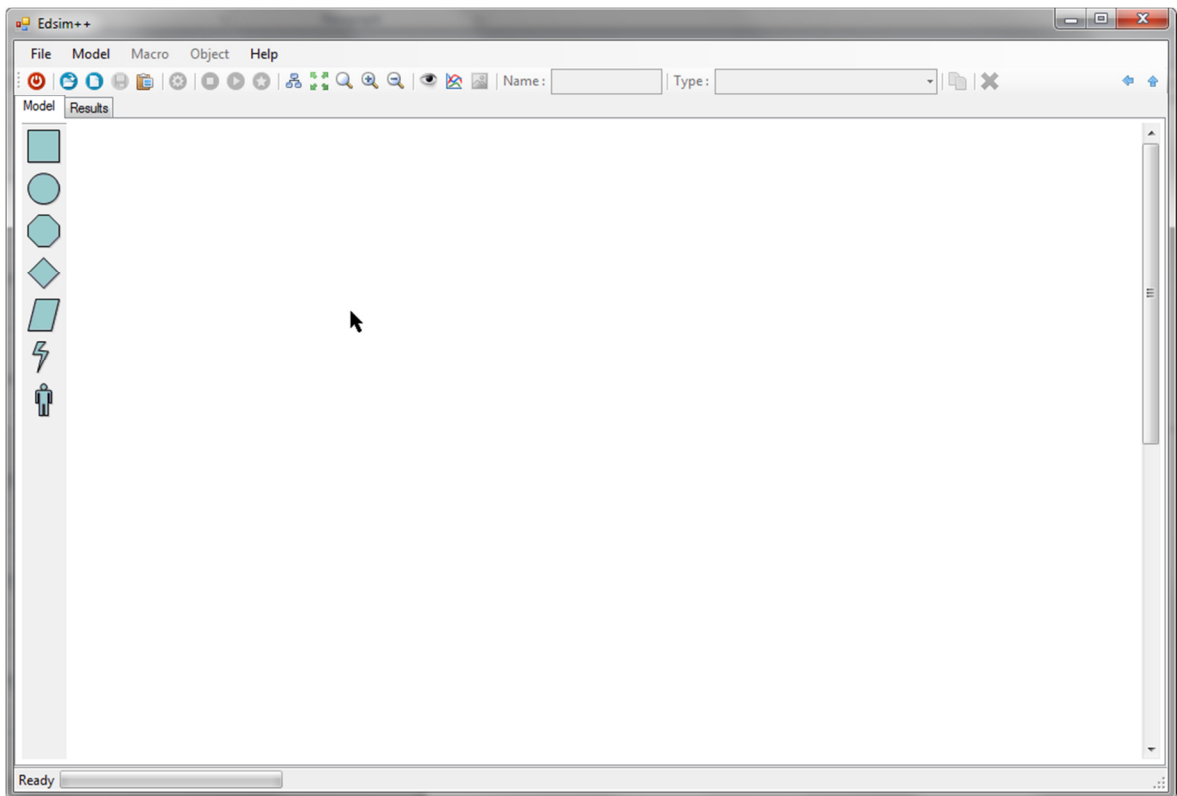

#### 3.2 Open a Model

Click on the File menu and select Open Model (File>Open>Model) or click on the open model button in the toolbar.

##### File>Model>Open

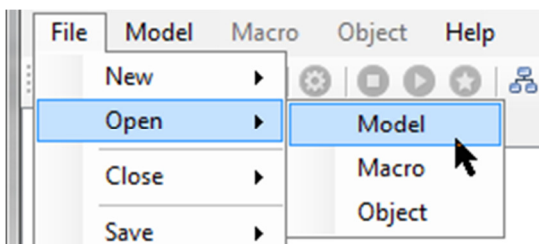

##### Open Model Button



Select the Demo.edx file in the open file dialog and click Open.

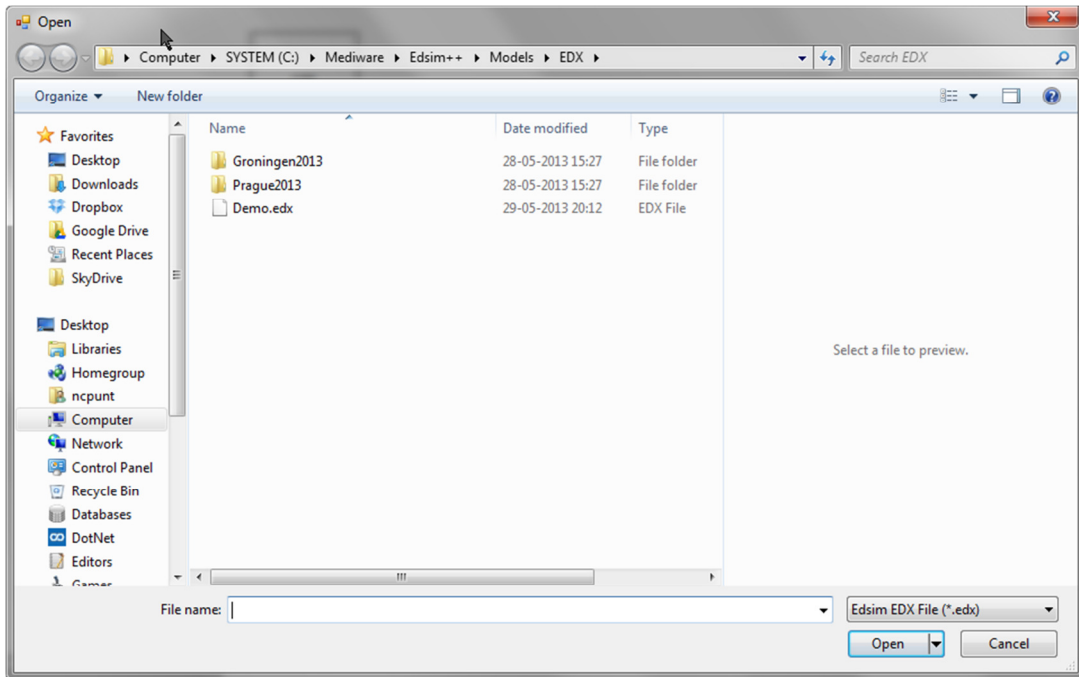

A standard 4-compartment model will be displayed on the Edsim++ desktop.

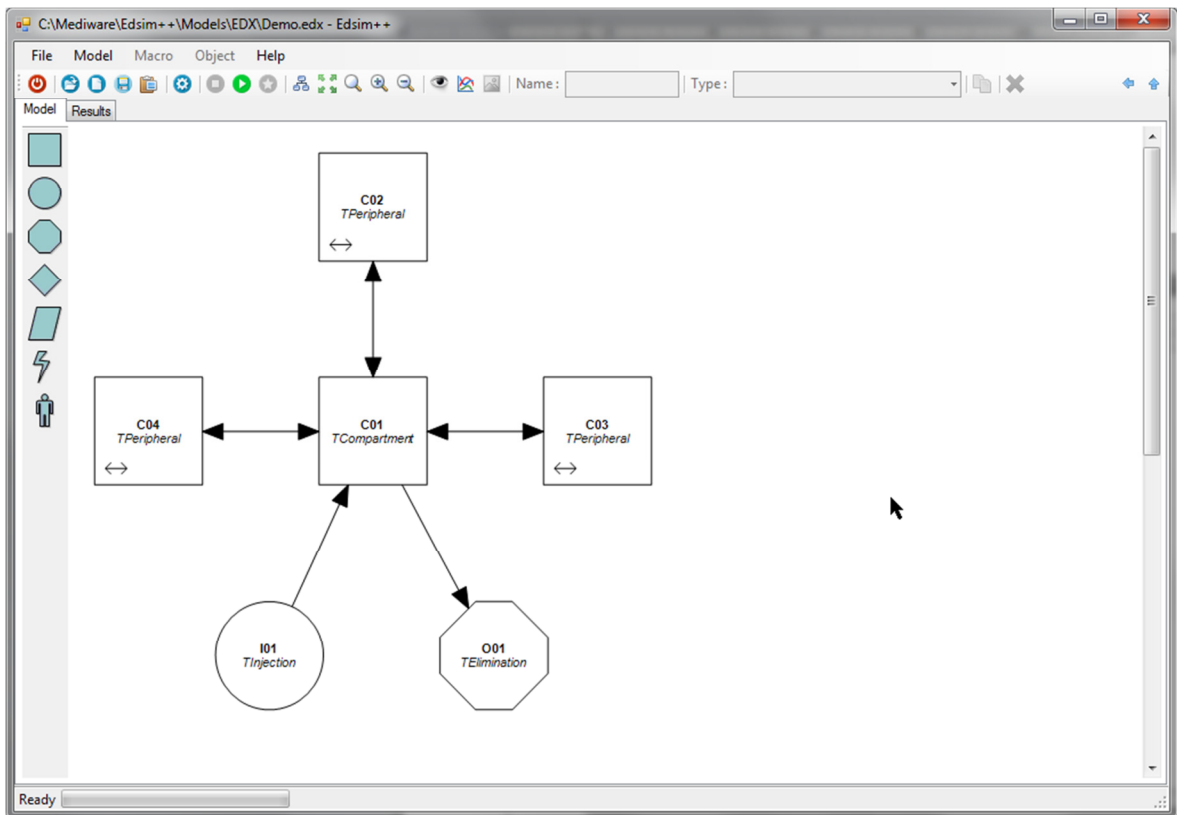

### 3.3 Simulate a Model

Now start a simulation by clicking the Run button:



The progress of the simulation is displayed in the progress bar at the bottom. A chart will appear after the simulation has been completed showing the concentration in all 4 compartments.

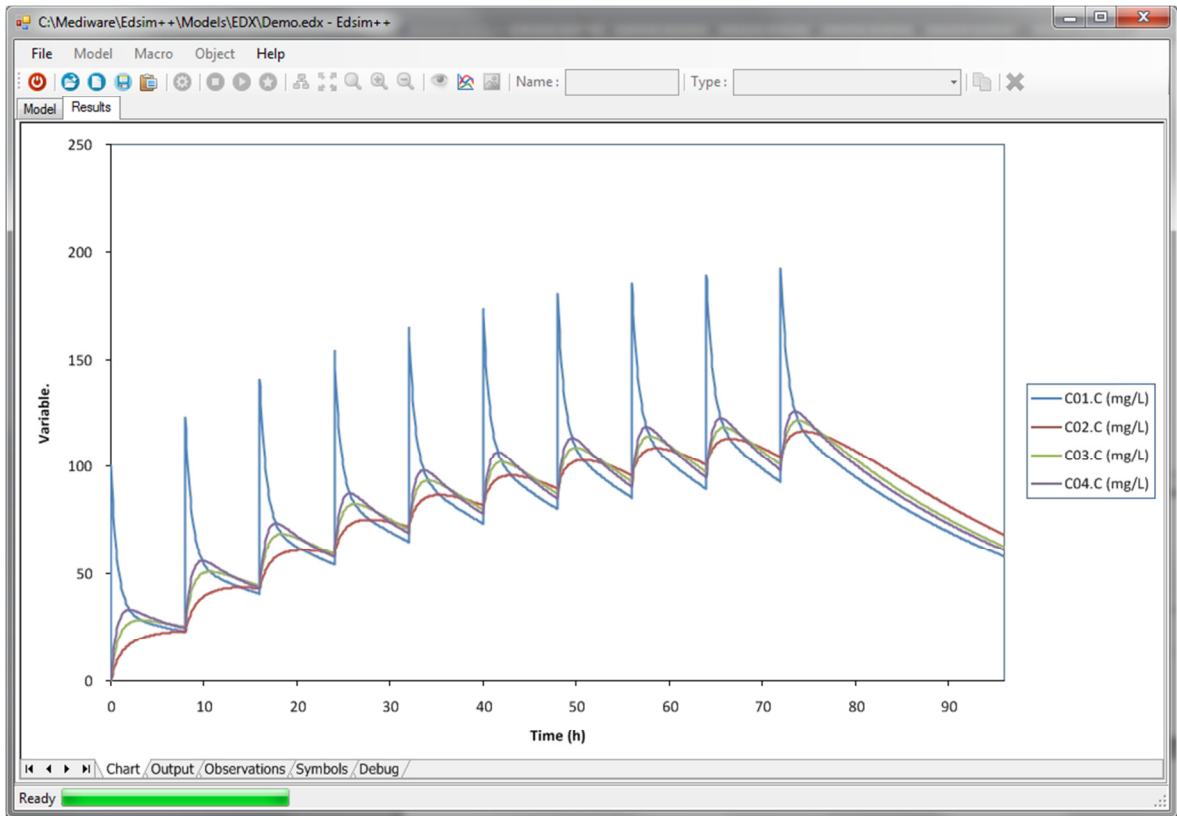

Click on the Output tab at the bottom of the screen in order to view the simulation output as a table.

The screenshot shows the Edsim++ interface with the 'Output' tab selected. The table displays simulation results for 27 rows. The columns are: Index, Type, Sys.Tsim, C01.C (mg/L), C02.C (mg/L), C03.C (mg/L), and C04.C (mg/L). The data shows a progression of 'Norm' types with increasing 'Sys.Tsim' values and corresponding concentration values for each compartment.

Index	Type	Sys.Tsim (h)	C01.C (mg/L)	C02.C (mg/L)	C03.C (mg/L)	C04.C (mg/L)
5	0 PreOn	0	0	0	0	0
6	1 PostOn	0	100	0	0	0
7	2 Norm	0	100	0	0	0
8	3 Norm	0.096	91.03348	1.814193	3.593346	5.33813
9	4 Norm	0.192	83.22171	3.434643	6.735935	9.908974
10	5 Norm	0.288	76.41312	4.885514	9.485308	13.81573
11	6 Norm	0.384	70.47607	6.187822	11.89152	17.14792
12	7 Norm	0.48	65.29626	7.359853	13.99811	19.98317
13	8 Norm	0.576	60.77442	8.417515	15.84297	22.38883
14	9 Norm	0.672	56.82436	9.374653	17.45907	24.42326
15	10 Norm	0.768	53.37122	10.24332	18.87513	26.1371
16	11 Norm	0.864	50.34999	11.03402	20.11613	27.57422
17	12 Norm	0.96	47.7042	11.75589	21.20384	28.77264
18	13 Norm	1.056	45.38481	12.41691	22.15724	29.76533
19	14 Norm	1.152	43.34925	13.02402	22.99285	30.58084
20	15 Norm	1.248	41.56051	13.58328	23.72509	31.2439
21	16 Norm	1.344	39.98645	14.09999	24.36652	31.77594
22	17 Norm	1.44	38.59918	14.57876	24.9281	32.19549
23	18 Norm	1.536	37.37444	15.02363	25.41943	32.51861
24	19 Norm	1.632	36.29116	15.43813	25.84885	32.75917
25	20 Norm	1.728	35.33105	15.82535	26.22367	32.9292
26	21 Norm	1.824	34.4782	16.18799	26.55028	33.03907
27	22 Norm	1.92	33.71881	16.52843	26.83427	33.09776

Click on the Model tab at the top. The model appears again.



Now click on the Mini Charts button in the toolbar:

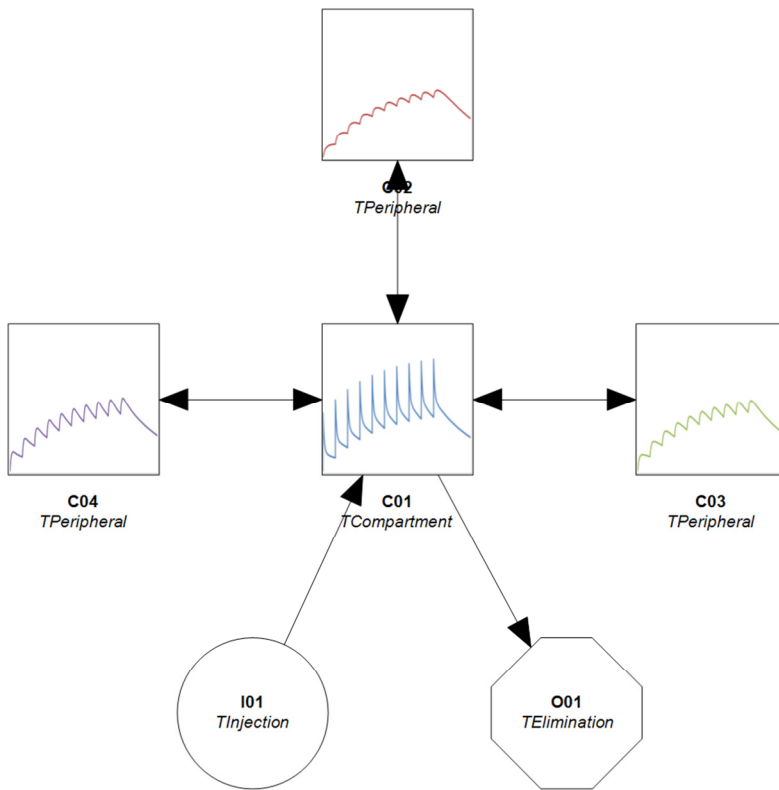

This will show the curves (concentration) in the object (compartment) they are associated with thereby supplying the user with a spatial view. Now double-click the TInjection object I01. The object properties window will appear from the right side.

Dose	Tnul	Tdur	Tint	Ndos
mg	h	h	h	
100	0	0	8	10

3.4 Modify a Model

Add another event (dosing) sequence of 5 times 150 mg every 12 hours starting at 100 h.

Dose	Tnul	Tdur	Tint	Ndos
mg	h	h	h	-
100	0	0	8	10
150	100	0	12	5

Now start another simulation by clicking the Run button:

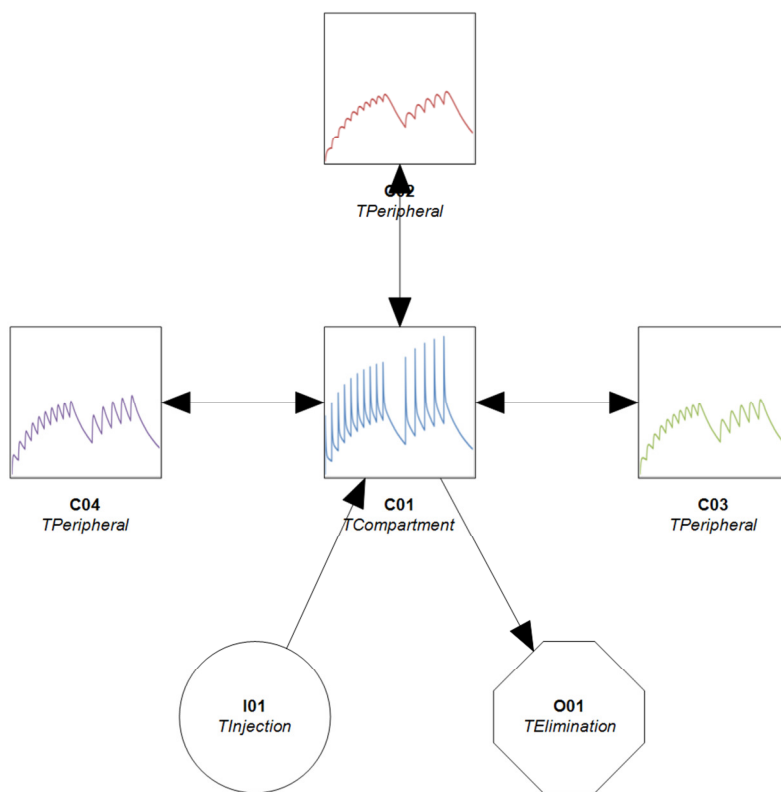

Click the left mouse button and the Alt key to bring up a magnifying glass.

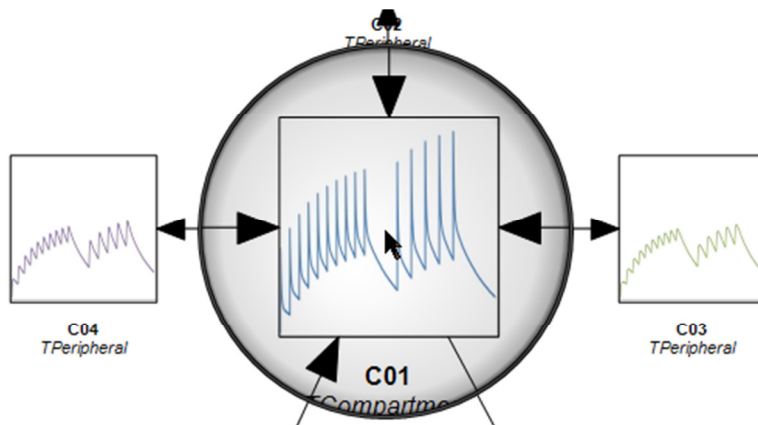

**3.5 Decorate a Model**

Select the TElimination object O01 by clicking on it.

Now click on the Select Image button: 

In the File Open dialog select the kidney.wmf image file in the Anatomy folder. The image will be displayed in the O01 object. Repeat this for the C04 object (Anatomy\Brain.wmf) and the I01 object (Admin\Injection.wmf). You have now decorated the model.

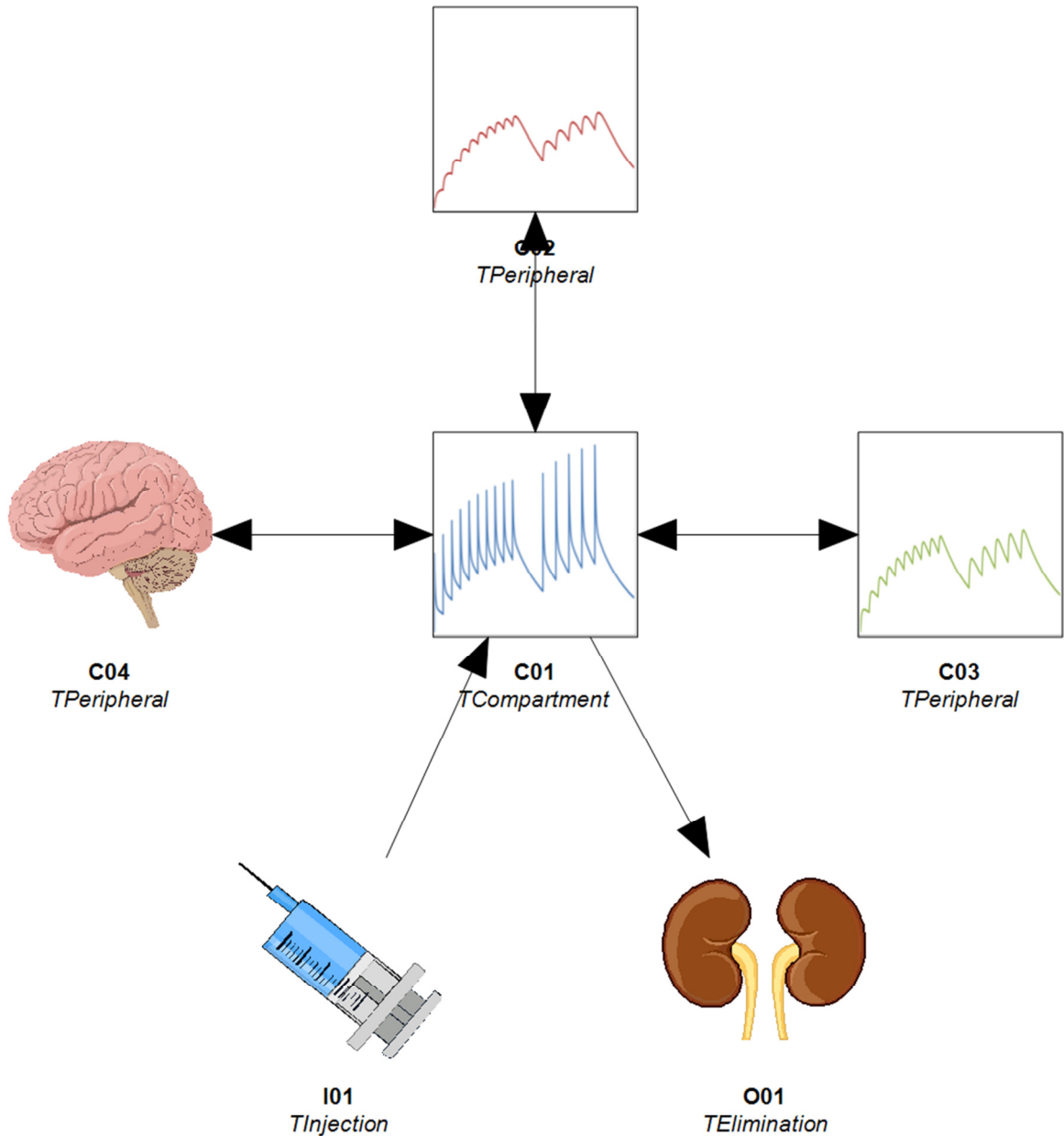

## 4 EDSIM++ DESKTOP

### 4.1 Overview

Below is an image of the Edsim++ desktop. All important elements are clearly identified.

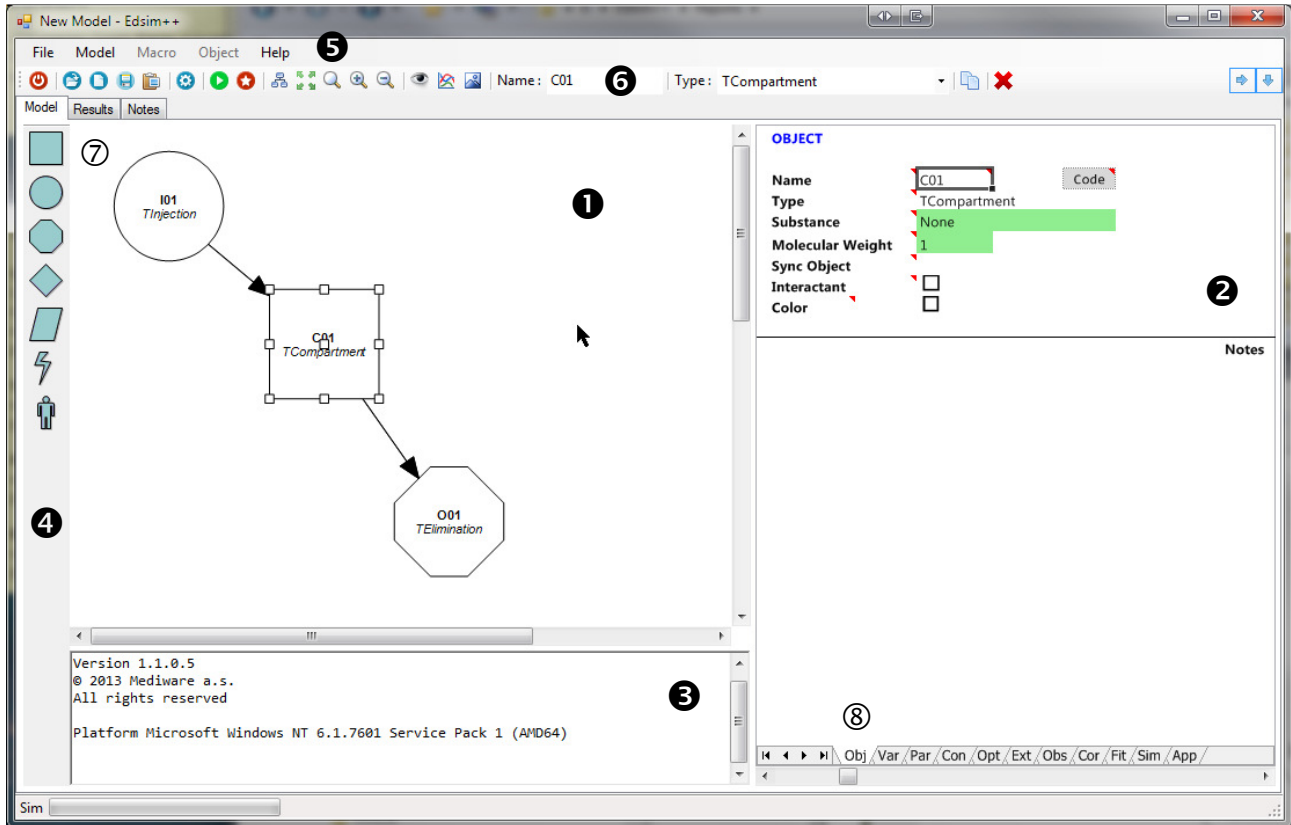

#### Main GUI elements:

1. Model desktop
2. Object properties (category tab is 8)
3. Error messages
4. Object templates (can be dragged to the model desktop)
5. Main menu
6. Tool bar
7. Model view tabs (model diagram, result data and plug-ins)
8. Object property category tabs.
  - a. Obj : Object
  - b. Var : Variables
  - c. Par : Parameters
  - d. Con : Constants
  - e. Opt : Options
  - f. Ext : Externals
  - g. Obs : Observations
  - h. Cor : Correlations
  - i. Fit : Fit settings
  - j. Sim : Simulation settings
  - k. App : Application settings (plot, colors, etc.)

**4.2 Adding Objects**

You can add objects to a model by dragging an object template on the desktop. Release the left mouse button at the position where you want to place to object.

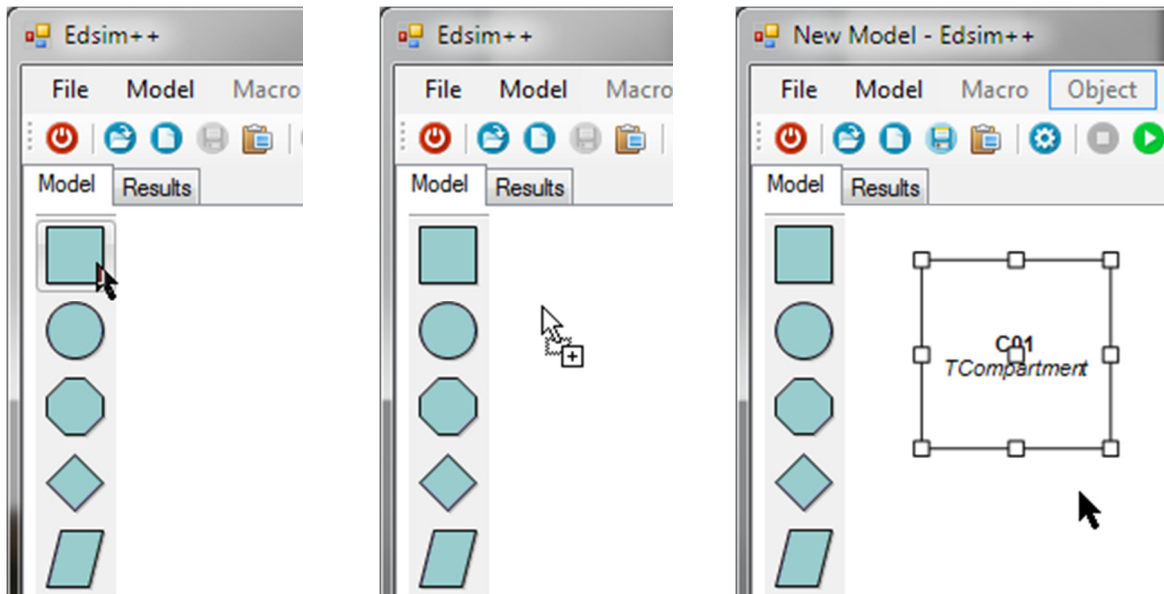

- 1. Select the template
- 2. Drag it on the desktop
- 3. Release the mouse button

**4.3 Manipulating Objects**

You can conduct three basic operations with an object: move, resize and connect (see diagram below).

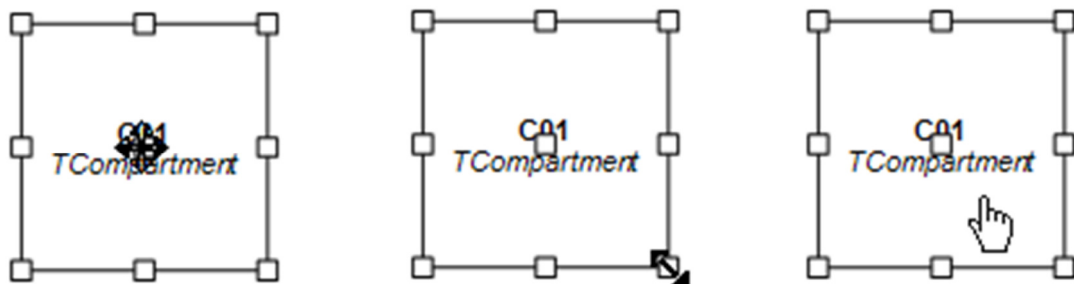

- Move object
- Resize object
- Connect object

Anchor points appear when you select an object. Click and drag the center anchor point in order to move the object. Click and drag one of the outer anchor points in order to resize the object. Click and drag on some free space within the object to initiate a connection.

**4.4 Connecting Objects**

Connections are links between a source object and a target object. You can connect objects by clicking on some free space in the source object and start dragging the mouse to some free space within the target object.

The  sign is shown if a connection cannot be made in a particular context. E.g. the direction of the link can be incorrect or the source and target may be incompatible.

1 Click on source



2 Start dragging

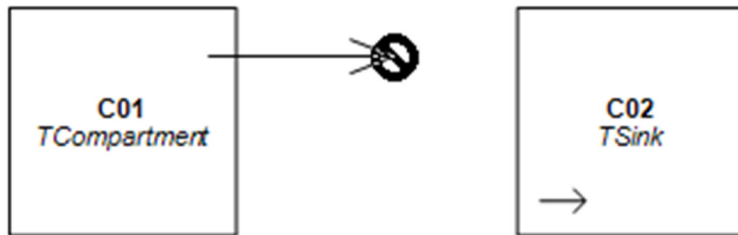

3 Drag to target

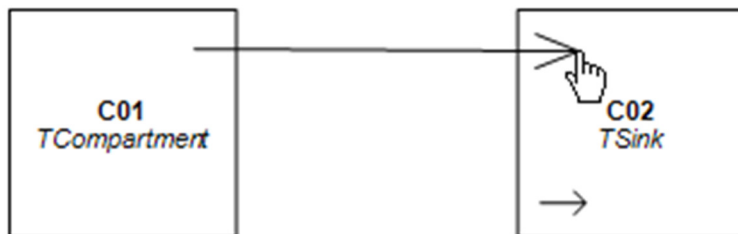

4 Release button



Incorrect Direction



Incompatible Objects

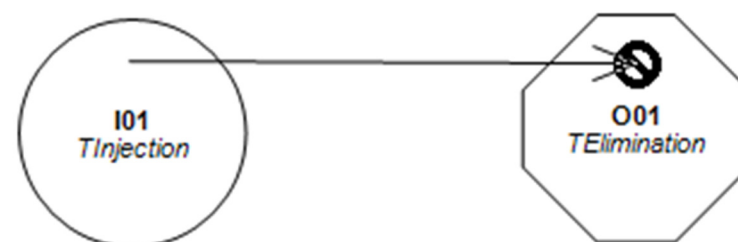

**4.5 Selecting Multiple Objects**

Select an object by clicking on some free space within the object boundaries. Repeat this process for other objects with the Ctrl key pressed in order to select multiple objects. You can also select multiple objects by dragging a box around the objects.

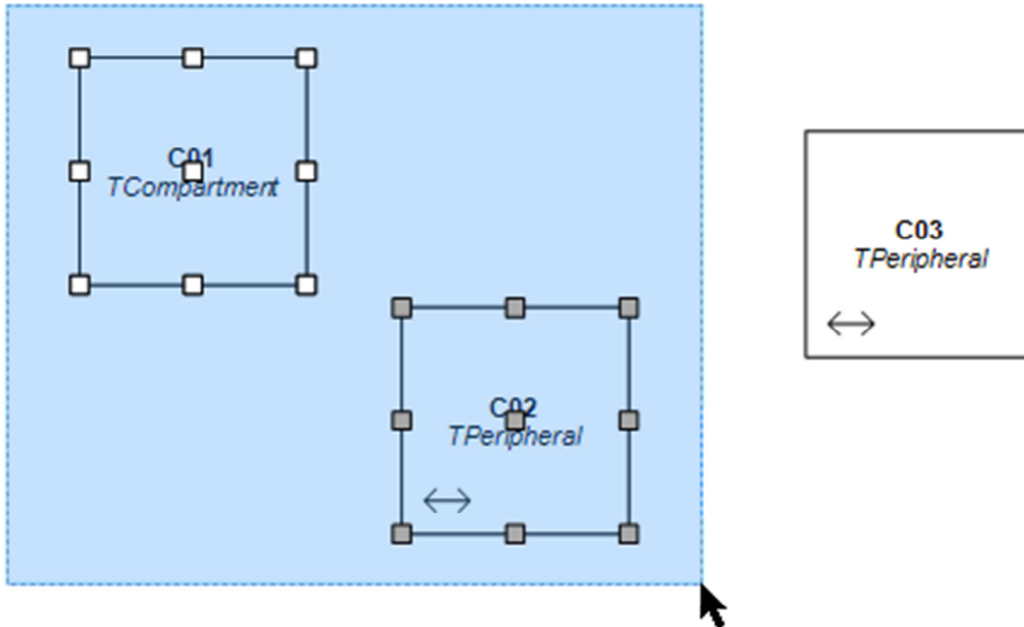

**4.6 Duplicating and Deleting Selected Objects**

Select one or more objects and press one of the following buttons on the toolbar.



Duplicates selected objects (including property values). The new and original objects will be automatically linked if they are compatible (e.g. TSink).



Delete selected objects.

**4.7 Object Name & Type**

The object name and type of the currently selected object is displayed in the toolbar at the top of the screen. You can give the object a new name or change its type. An object must have a unique name among all the objects on the desktop. Edsim++ will generate a name and type automatically when you add or duplicate an object.

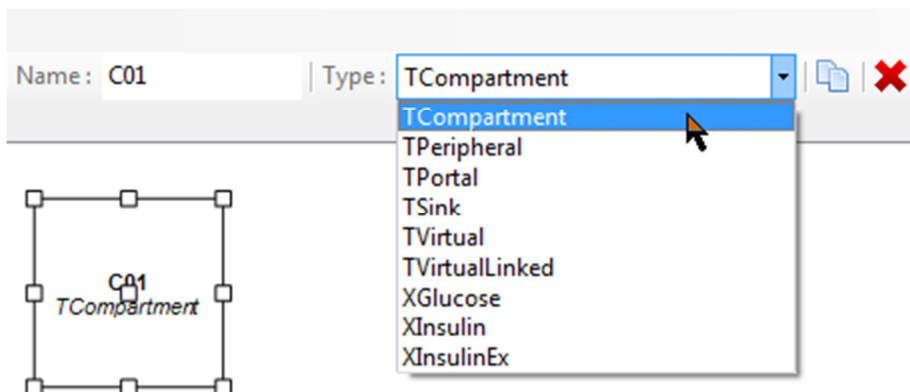

4.8 Object Properties

Double-clicking an object brings up the object properties window from the right side. Clicking the → button hides this window again. Double-clicking on some free space on the model desktop toggles the visibility of this window.

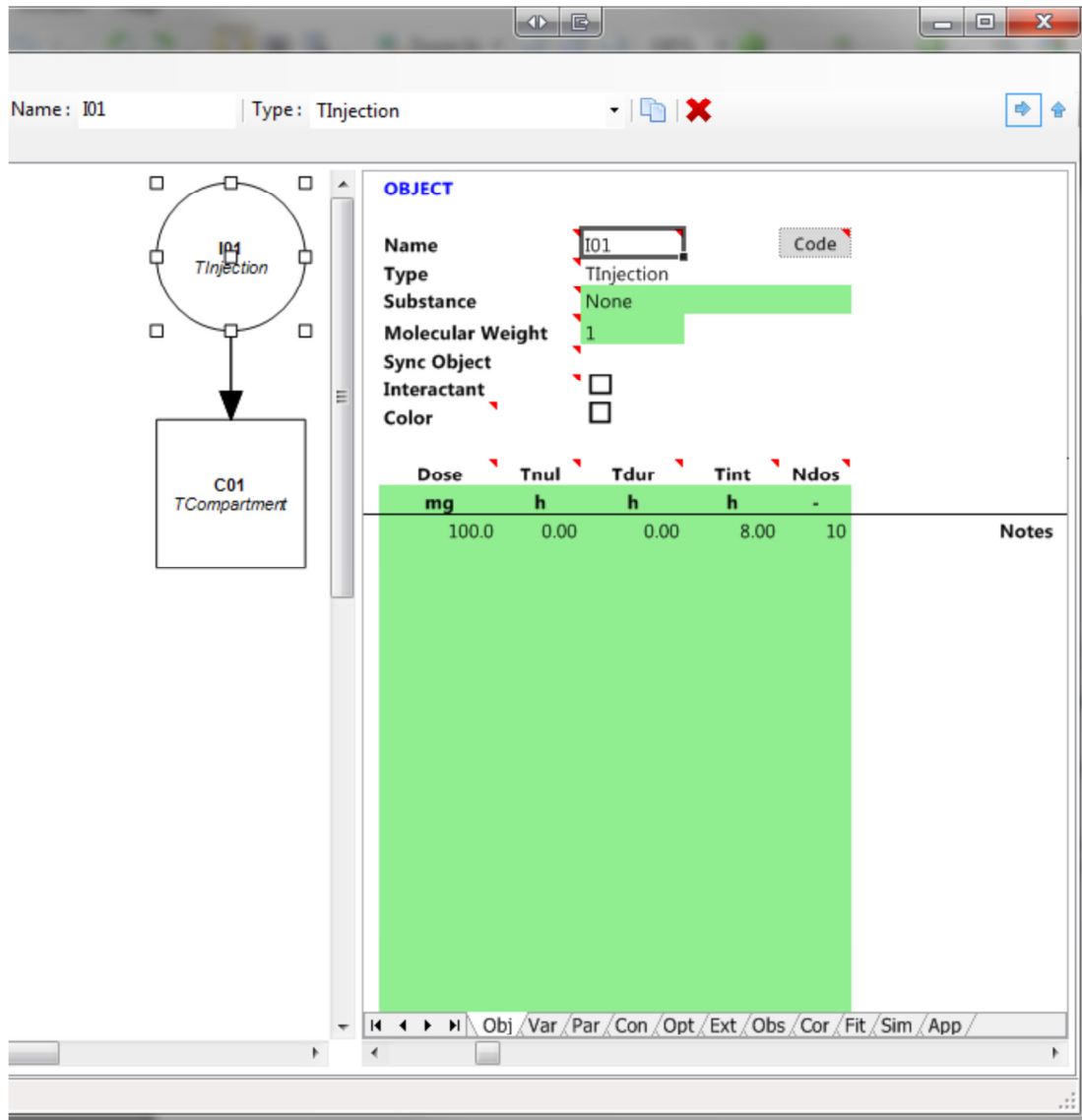

The tabs in object properties window represent different categories of properties.









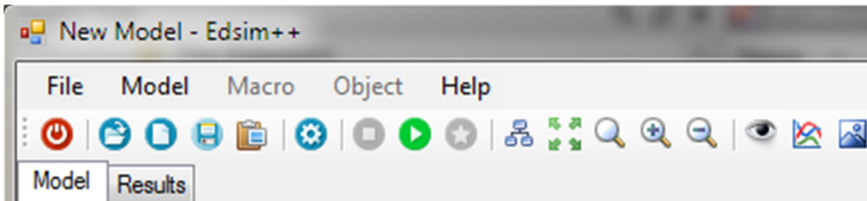







- Obj : Object (dosing sequences)
- Var : Variables (select which variables must be observed during a simulation)
- Par : Parameters (select which parameters must be fitted during a fit)
- Con : Constants (constant symbol values)
- Opt : Options (named symbol values)
- Ext : Externals (constitute the interface between objects)
- Obs : Observations (measurement values that can be fitted)
- Cor : Correlations (between parameters)
- Fit : Fit settings (fit method)
- Sim : Simulation settings (simulation method)
- App : Application settings (plot, colors, etc)



**4.9 Toolbar Buttons**

The function of the toolbar buttons is explained here.



-  Exit Edsim++
-  Open an existing model
-  Create a new model (clearing the existing model)
-  Save current model
-  Copy a bitmap image of the current model or chart to the clipboard
-  Build the current model (or compile the current macro)
-  Abort running simulation or fit procedure (e.g. if it is taking too long to complete)
-  Simulate the current model
-  Fit the current model
-  Lay-out model automatically
-  Zoom to fit. Zoom in or out so that all model objects are visible.
-  Cancel zoom. Restore zoom to its original state (100%)
-  Zoom in in steps of 10%
-  Zoom out in steps of 10%
-  Show or hide link numbers
-  Show or hide mini graphs
-  Assign an image to an object

**4.10 Menu Items**

The following table lists all menu entries and their function. Please note that the terms Macro (model expressed as C# source code) and Object (object expressed as C# source code) will be explained later in this manual.

Level 1	Level 2	Level 3	Description
<b>File</b>	New	Model	Create a new model
		Macro	Create a new macro
		Object	Create a new object
	Open	Model	Open an existing model from file
		Macro	Open an existing macro from file
		Object	Open an existing object from file
	Merge	Model	Merges a model into an existing model.
		Metabolite	Connects a metabolite model to an existing model.
	Close	Model	Close current model
		Macro	Close current model
		Object	Close current object
	Save	Model	Save current model to file using the existing name
		Macro	Save current macro to file using the existing name
		Object	Save current object to file using the existing name
	Save As	Model	Save current model to file using a new name
Macro		Save current macro to file using a new name	
Object		Save current object to file using a new name	
Print	Model	Print current model	
	Results	Print current results set	
Restart			Restart Edsim++ (required after a library build)
Exit			Ext Edsim++
<b>Model</b>	Build		Build the current model
	Convert to Macro		Convert the current model to a macro (C# source)
	Run	Normal	Simulate the current model
		Variable Error	Simulate and show error (SD) of observed variable.
		Parameter Sensitivity	Simulate and show partial derivatives of fitted parameter
		Confidence Interval	Simulate and show 95% confidence interval
Fit		Build and fit the current model	
<b>Macro</b>	Insert Object		Insert object declaration into macro C# code
	Build		Compile the current macro
	Convert to Model		Convert the current macro to a model
	Run		Build and simulate the current macro
	Fit		Build and fit the current macro
<b>Object</b>	Build		Compile the current object
	Build Library		Build library by compiling all available objects
	Restore Library		Restore the factory default library
<b>Help</b>	Manual		Show manual
	Library		Show PKPD object library
	Knowledge base		Show knowledge base document
	Release Notes		Show release notes
	About Edsim++		Show version and license information



## 5 EDSIM++ MODELS





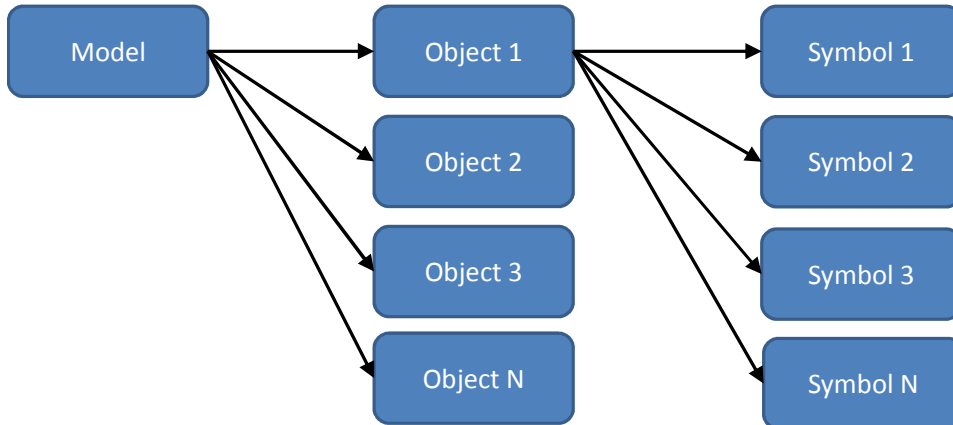

### 5.1 Model Structure

The generic structure of a model is displayed below. A model consists of one or more objects, each object representing a particular PKPD process (e.g. absorption, distribution or elimination). In turn, each object is built of a number of symbols. These symbols used in the PKPD equations.



### 5.2 Object Categories

Edsim++ objects are the building blocks of a model. We discriminate between seven different object categories.

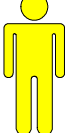
	<b>Compartment</b>	A compartment is a container for a material (substance, drug)
	<b>Input</b>	An input introduces new material in a compartment
	<b>Output</b>	An output removes material from a compartment
	<b>Transfer</b>	A transfer moves material from a source to a target compartment
	<b>Effect</b>	An effect is calculated from a concentration in a compartment
	<b>Tool</b>	A tool object is used for generic tasks like addition and integration
	<b>Patient</b>	A patient object is typically used for allometric parameter scaling

We refer to the “Edsim++ PKPD-Library” manual and video tutorials for a complete list and detailed description of all objects available in Edsim++.

### 5.3 Symbol Categories

Symbols are the building blocks of an object and are used in equations defined within that object. We discriminate between the following symbol categories.

Type	Subtype	Description
<b>Constants</b>	Event Constants	Invariant symbols used in event equations
	Option Constants	Invariant symbols used for setting object options
<b>Parameters</b>	Fittable Parameters	Time-invariant symbols that can be fitted
	Non-Fittable Parameters	Time-invariant symbols that cannot be fitted
<b>Variables</b>	Interpolated Variables	Time variant symbols that must be interpolated
	Differential Variables	Time variant symbols that must be integrated

### 5.4 Editing Model Properties

#### 5.4.1 [Obj]: Object Tab

**OBJECT**

**Name**

**Type** Infusion

**Substance** None

**Molecular Weight** 1

**Sync Object**

**Interactant**

**Color**

Dose	Tnul	Tdur	Tint	Ndos
mg	h	h	h	-
100	4	1	8	10

Here you can specify the name and molecular weight of the substance. You can mark an object as being an “interactant” so that it can be discriminated from another object of the same type participating in an interaction. Also the display color can be set here.

Objects can be synchronized to events occurring in other objects (the synchronization object). This sync mechanism is typically used to reset a calculated AUC or average concentration using events occurring in an input object.

Some objects support events. A number of event sequences can be entered in the event table. The timing of these sequences may overlap each other, allowing for very complex time tables. The example above represent an infusion dosing schedule in which 100 mg (Dose) is given at time 4 h (Tnul) for a duration of 1 h (Tdur) with an interval time of 8 h (Tint). In total 10 dosages are given (Ndos). These event values are considered to be a special kind of constants (event constants).

5.4.2 [Var]: Variables Tab

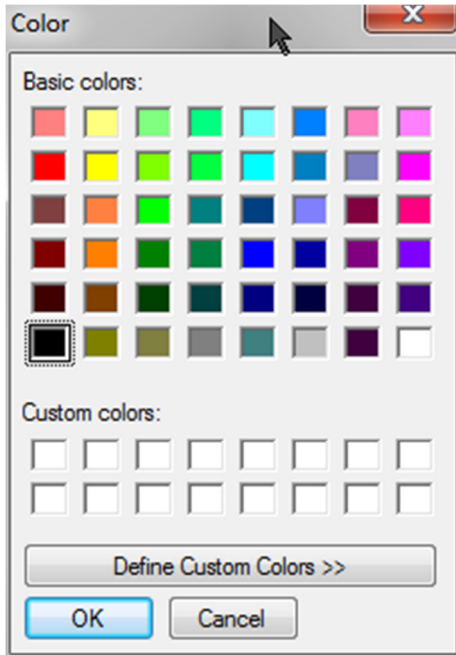
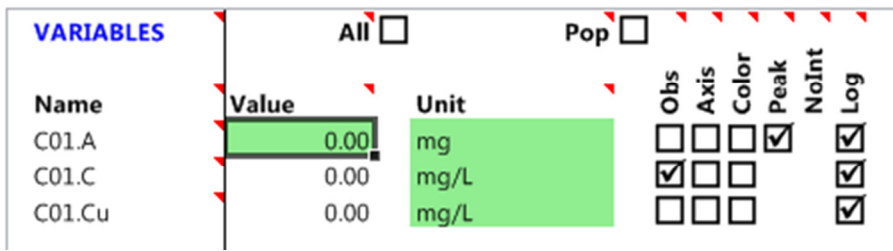

The variables tab lists all the variables associated with the selected object (or all objects if the All box is checked). Here you can change the initial value (or population value if the Pop box is checked) and the unit of the variable. You can also mark variables as Observed (Obs box) so that it is shown in the output chart. The Axis property assigns the variable to the left y-axis (unchecked, default) or right y-axis (checked).

You can select a curve color for a variable when you click on the Color box. A white color means that the colors are assigned automatically by Edsim++.

By checking the Pop box you can enter population values which are used for allometric scaling of parameters (see next paragraph). A description window will be displayed if you move the cursor over the name of a symbol.

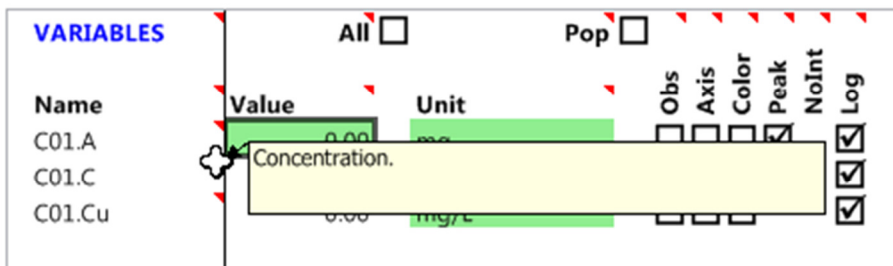

By increasing the object properties window size additional properties are revealed which are important for fitting.



Here the weighting method of the variable can be selected (OLS vs WLS) and the assay error can be specified as a polynomial function of the concentration (see chapter 9 on fitting for more details).

The variable value field uses the following color coding:

	Default variable value equals population value
	Non-default variable value equals population value
	Variable value differs from population value
	Read-only variable value

5.4.3 [Par]: Parameters Tab

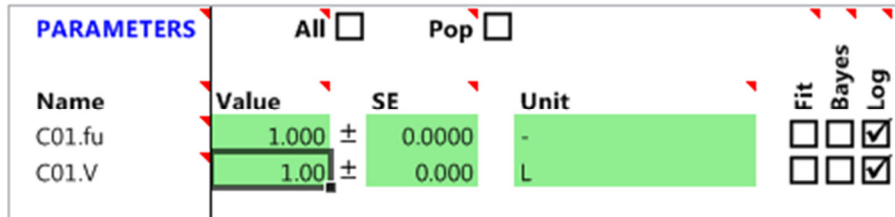

The parameters tab lists all the parameters associated with the selected object (or all objects if the All box is checked). Here you can change the value, standard error and unit of the parameter. Check the Fit box if you want to estimate the parameter during fitting. Check the Pop box in order to enter a population value or standard deviation. Check the Bayes box in order to select this parameter for Bayesian fitting. Check the Log box to indicate that the parameter is log-normally distributed.

By increasing the object properties window size additional properties are revealed. Here you can select the symbol used for allometric scaling of the parameter. Also an allometric scaling factor can be specified. Finally the display format for the scaled unit can be entered (0=L/kg, 1=L/kgLbm, 2=L/70kg or 3=L/70kgLbm).

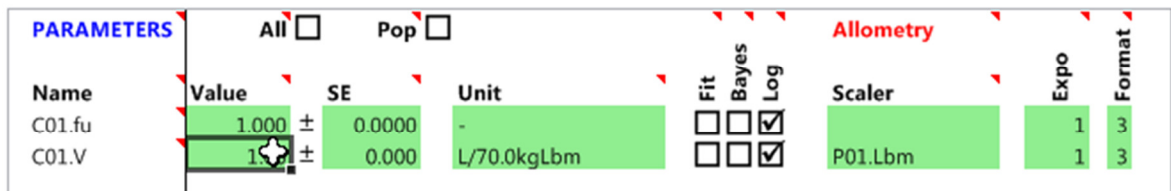

In this example the volume of distribution (V) is scaled using the patient body lean body mass (Lbm). The normalized value of the parameter is displayed in the value field.

$$V = V_{pop} \cdot \left( \frac{Lbm}{Lbm_{pop}} \right)^b$$

Scaled

$$V = \frac{V_{pop}}{Lbm_{pop}^b} \cdot Lbm^b$$

Rearranged

$$V = V_{norm} \cdot Lbm^b$$

Normalized

The parameter value field uses the following color coding:

	Default parameter value equals population value
	Non-default parameter value equals population value
	Parameter value differs from population value
	Read-only parameter value

5.4.4 [Con]: Constants Tab

CONSTANTS		
Name	Value	Unit
P01.HistSize	10.00	-
P01.KChild	0.55	-
P01.MaxIT	20.00	-
P01.StopIT	0.000001	-

The constants tab lists all the constants associated with the selected object (or all objects if the All box is checked). Here you can change the value and unit of the constant. In the example above the constants of TPatient object P01 are displayed.

5.4.5 [Opt]: Options Tab

OPTIONS	
Name	Value
P01.Mode	Interpolate observed Ccr
P01.Prefit	No
P01.Race	Caucasian
P01.RFunc	Jelliffe 21
P01.RFuncW	Lbm
P01.Sex	Male

The options tab lists all the options associated with the selected object (or all objects if the All box is checked). Options are a special kind of constants in which the values are associated with a name. They can be regarded as so called enumerations. The example above lists all options associated with a patient object.

5.4.6 [Ext]: Externals Tab

EXTERNALS	
Name	External Name
O01.Ax	A
O01.Vx	V

The externals tab lists all the externals associated with the selected object (or all objects if the All box is checked). Externals are symbols that are required by an object but are defined in another object. So the list of external symbols represents the interface of an object.



The previous example shows the externals of a TElimination output object O01. This elimination object requires the amount A and volume V symbols of a connected source compartment. Within the elimination object these symbols are referenced as Ax and Vx. In this example the external name is fixed and cannot be changed by the user.

The following example shows the externals of a TIntegrator tool object. Here the user is free to change the externally referenced symbol name used for integration.

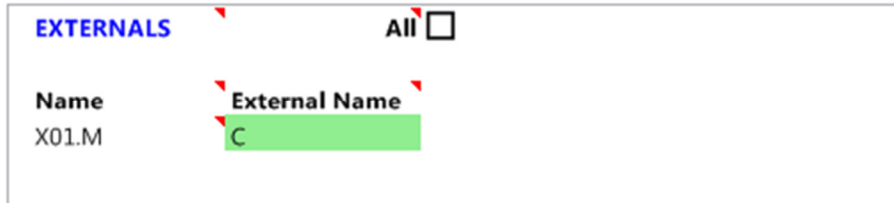

5.4.7 [Cor]: Correlations Tab

The correlations tab lists the correlations between fitted parameters. These values can be obtained by a fit or entered manually. Also fixed parameters will be shown if the All box is checked (default). Population parameter correlations are shown if the Pop box is checked.

CORRELATIONS All  Pop

	Value	SE	C01.fu	C01.V	C02.fu	C02.kxy	C02.kyx	IM.A0	IM.F	IM.k	IM.t0	ME.k	P.Fd	RE.k	Unit
C01.fu	0.900 ± 0.0000		1												-
C01.V	0.147 ± 0.0049			1											L/kgLbmc
C02.fu	0.000 ± 0.0000				1										-
C02.kxy	0.0646 ± 0.02124			-0.606193		1									1/h
C02.kyx	0.0573 ± 0.02027			-0.509300		0.961518	1								1/h
IM.A0	0.00 ± 0.000							1							mg
IM.F	1.000 ± 0.0000								1						-
IM.k	3.000 ± 0.00000									1					1/h
IM.t0	0.00 ± 0.000										1				h
ME.k	0.0150 ± 0.00000											1			1/h
P.Fd	0.40 ± 0.000												1		-
RE.k	0.00211 ± 0.000151			-0.797769		0.950071	0.882495							1	1/h/(mL/min/1.73m <sup>2</sup> )

If you uncheck the all box on the fitted parameters are displayed so that a typical parameter correlation matrix emerges.

CORRELATIONS All  Pop

	Value	SE	C01.V	C02.kxy	C02.kyx	RE.k	Unit
C01.V	0.147 ± 0.0049		1				L/kgLbmc
C02.kxy	0.0646 ± 0.02124		-0.606193	1			1/h
C02.kyx	0.0573 ± 0.02027		-0.509300	0.961518	1		1/h
RE.k	0.00211 ± 0.000151		-0.797769	0.950071	0.882495	1	1/h/(mL/min/1.73m <sup>2</sup> )

5.4.8 [Obs]: Observations Tab

The observations tab lists all the observations associated with the selected object (or all objects if the All box is checked). Observations are organized in a matrix in which the first column represents the observation time. Subsequent columns hold the values for a particular variable which can be selected on the top row of the table. Simply leave cells blank on time points where you do not have all variable values.

OBSERVATIONS					All <input checked="" type="checkbox"/>
Time	C01.C	P.Bw	P.Ccr		
(h)	mg/L	kg	μmol/L		
0			68	100	
37	8.2				
47.9167	2.4				
72		70	97		
95.9167	1.5				
97	7.3				
119.917	1.3	68	110		

It is also possible to specify an (assay) error for each entered variable value. You can do this by selecting an entry from the variable list with an “.sd” postfix. In the example below the assay error of the concentration in the central compartment (C01.C.Sd) was entered.

OBSERVATIONS					All <input checked="" type="checkbox"/>
Time	C01.C	C01.C.Sd	P.Bw	P.Ccr	
(h)	mg/L	mg/L	kg	μmol/L	
0				68	100
37	8.2	0.82			
47.9167	2.4	0.24			
72			70	97	
95.9167	1.5	0.15			
97	7.3	0.73			
119.917	1.3	0.13	68	110	

Variable errors entered this way take precedence over the polynomial assay error function during a WLS fit.

5.4.9 [Fit]: Fitting Tab

The fitting tab displays all fitting settings like fitting method (Simplex or Marquardt), stop criterion, the maximum number of allowed iterations (0 means no limitation), the number of iterations at which the output should be updated and the maximal allowed parameter change factor. Check the Bayes box for a Bayesian fit. This requires at least 1 fitted Bayesian parameter. Check the Correlated Bayes Box in order to take the population correlation matrix into account.

**FITTING**

Bayes

Correlated Bayes

Method **Marquardt**

Stop criterion **1.00E-06**

Max iterations **0**

Output iterations **1**

Parameter factor **10**

5.4.10 [Sim]: Simulation Tab

**SIMULATION**

**PRIMARY**

Duration **0** h

Resolution **1000**

Integration method **RK4 Adaptive**

**SECONDARY**

Fixed step size **0.1**

Adaptive step factor **0.15**

Integration accuracy **1.00E-06**

Peak/Level accuracy **2.77778E-06**

Peak detection **Approximation**

Level detection **None**

**OUTPUTS**

Normal outputs

Observation outputs

Event outputs

**PROFILING**

Use profile

Event object

Profile variable

Tthrough **-0.5**

Tpeak **0.5**

This screen displays all simulation settings. In the primary section the simulation duration, resolution and integration method can be specified. Edsim++ will establish a simulation duration automatically when a value of 0 is entered here. The automatically derived simulation duration is based on the number of events and event time interval.

In the secondary section more low level simulation settings can be specified. These settings directly control the integrator which is used for solving the differential equations. In the outputs section the user can specify when the simulator should generate an output value. Normal outputs are driven by the selected simulation resolution. Observation and event outputs are triggered by the occurrence of an event or observation at a particular time.

The profiling section contains the settings for the profile simulation mode. In this mode additional outputs can be generated at particular time points. These additional values are outputs at Ttrough, Tpeak and Tmax. Trough and Tpeak outputs also require the “observation outputs” setting to be checked. Also an event object and profile variable must be specified. Below is a typical setup for a profile simulation in which only the normal outputs have been disabled.

**OUTPUTS**

Normal outputs

Observation outputs

Event outputs

**PROFILING** +

Use profile

Event object I01

Profile variable C01.C

Trough -0.5

Tpeak 0.5

This yields the following results in a 4-compartment model with extravascular administration (dosing interval time is 8 hours) over a period of 2 dosing intervals.

	A	B	C	D	E	F	G	H
1	<b>SIMULATION OUTPUT</b>							
2								
3	<b>Index</b>	<b>Type</b>	<b>Sys.Tsim</b>	<b>C01.C</b>	<b>C02.C</b>	<b>C03.C</b>	<b>C04.C</b>	
4	(-)	(-)	(h)	(mg/L)	(mg/L)	(mg/L)	(mg/L)	
5	0	PreOn	0	0	0	0	0	
6	1	PostOn	0	0	0	0	0	
7	2	Obs	0.5	30.9204	1.756336	3.391213	4.91376	
8	3	Max	1.248	40.78229	6.783536	12.35364	16.93637	
9	4	Obs	7.5	24.32637	22.47757	26.23317	26.33266	
10	5	PreOn	8	23.84874	22.63016	25.84233	25.74702	
11	6	PostOn	8	23.84874	22.63016	25.84233	25.74702	
12	7	Obs	8.5	54.31862	24.48049	28.82965	30.10703	
13	8	Max	9.216	63.53834	29.3375	36.83787	40.92598	
14	9	Obs	15.5	42.81409	43.32859	46.3659	45.88368	
15	10	PreOn	16	42.04574	43.24218	45.64956	44.98277	
16	11	PostOn	16	42.04574	43.24218	45.64956	44.98277	

5.4.11 [App]: Application Tab

**DIAGRAM**

Desktop

Objects

Links

**PLOT**

X Variable

Y Variable

X Log scale

Y Log scale

X Grid lines

Y Grid lines

**EXPORT**

Start Excel

Start Visio

In the diagram section of the application tab the default color for the desktop, objects and links can be specified. Please note that the color for individual objects can be controlled in the object tab.

In the plot section the user can select which symbol is the x-variable (default Tsim) and which symbol is the y-variable (default blank). A blank entry for y-variable means that all observed variables will be shown in the chart. The user can also specify if an axis should be log scaled and if grid lines should be displayed.

In the export section the user can specify if the application supporting a particular export format should be automatically launched after the export has been completed.

## 6 BUILDING MODELS

### 6.1 One-compartment Model

Start Edsim++ and drag the following objects on the desktop: a compartment, an input and an output.

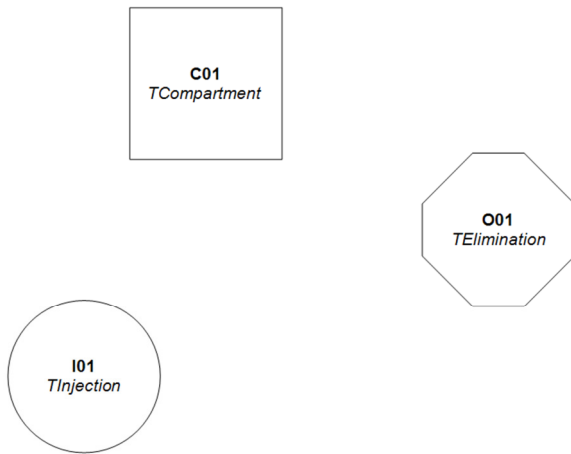

Now connect injection I01 (source) with the compartment C01 (target). Next connect compartment C01 (source) with the elimination O01 (target).

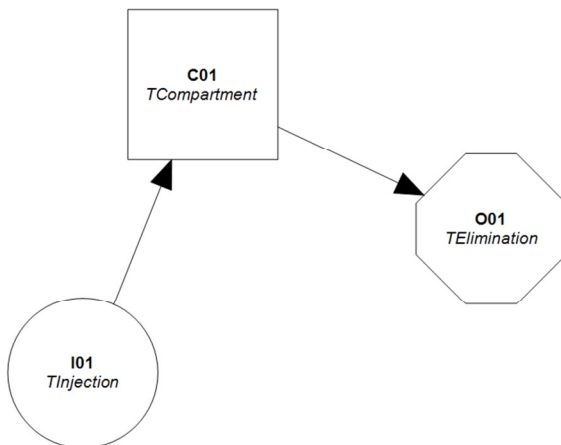

Next click on the mini chart button  followed by the run button  (on the toolbar)

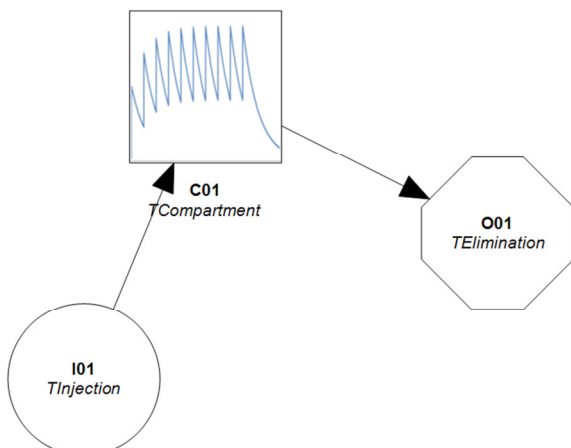

One of the great features of Edsim++ is that all objects are equipped with smart default values so that when you are done building a model you can directly simulate it. Now double-click the elimination object O01. Select the parameters tab (Par) and increase the elimination rate constant from 0.1 to 0.5 (1/h). Run a simulation again.

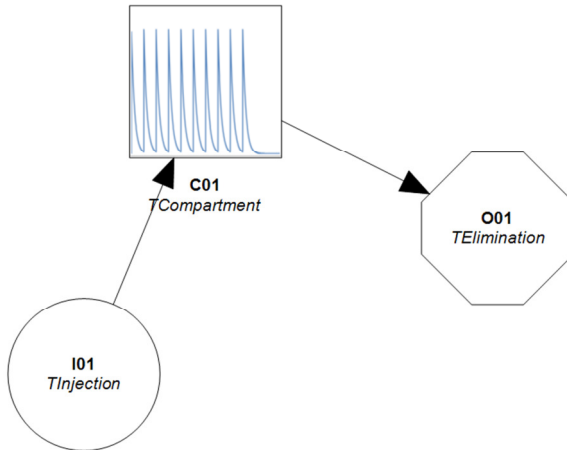

Note how the concentration profile has changed. Now click on the Results tab at the top followed by clicking on the Symbols sub-tab at the bottom of the application window. Closely look at the parameters lists. All non-default parameters are marked with a yellow color. This will help you to identify those parameters you forgot to enter yourself. Please note that all data in the Results tab is only updated after a simulation.

Parameters	
C01.V	1 L
O01.k	0.5 1/h

Now double-click the elimination object O01 again. Select the options tab (Opt) and change the Mode option from Rate to Clearance. Now select the parameters tab (Par) again. Note how the rate constant k (1/h) has been replaced with clearance CL (L/h).

The screenshot shows the 'PARAMETERS' window in Edsim++. At the top, there are checkboxes for 'All' and 'Pop'. Below this is a table with columns for 'Name', 'Value', 'SE', and 'Unit'. The 'O01.CL' parameter is highlighted in yellow, with a value of 0.50 and a standard error of 0.000, and a unit of L/h. Other parameters shown include O01.k (0.5000, 0.00000, 1/h) and O01.th (1.39, 0.000, h). On the right side of the window, there are checkboxes for 'Fit', 'Bayes', and 'Log', with 'Log' checked.

Name	Value	SE	Unit
O01.CL	0.50 ± 0.000	0.000	L/h
O01.k	0.5000 ± 0.00000	0.00000	1/h
O01.th	1.39 ± 0.000	0.000	h

Many Edsim++ objects support this feature of switching between rate and clearance mode.

**6.2 Two-Compartment Model**

Continue with the 1-compartment model from the previous paragraph. Drag another compartment on the desktop. Drag another compartment on the desktop.

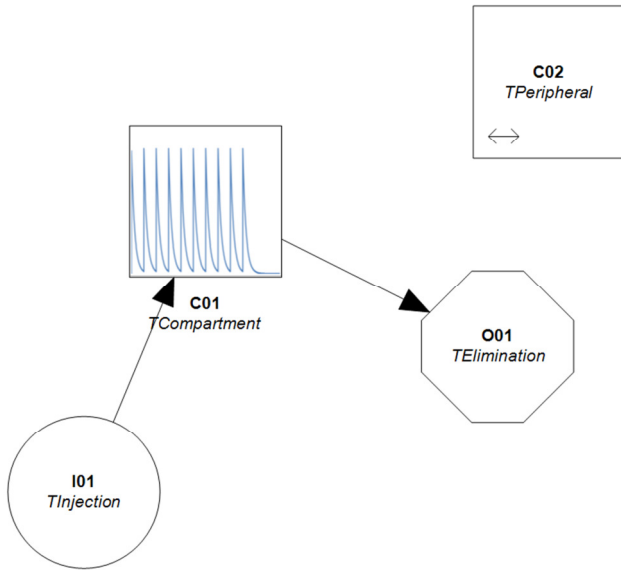

Please note that the 2<sup>nd</sup> compartment is automatically created as a peripheral compartment. Now connect compartment C01 (source) with compartment C02 (target) and run a simulation.

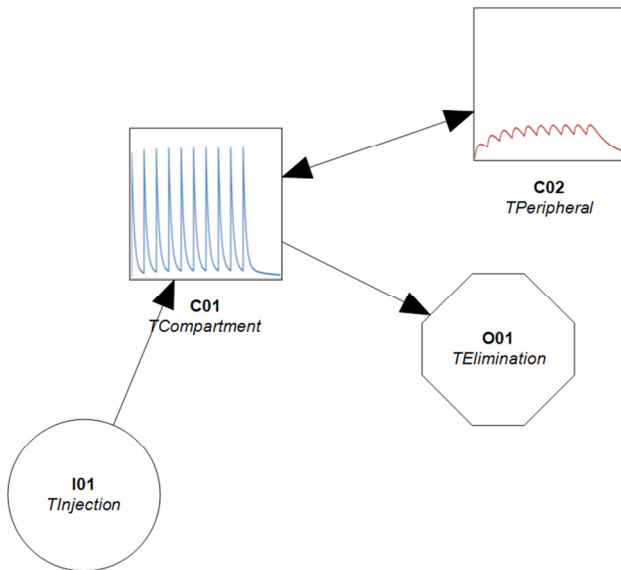

Note that the connection between the central compartment C01 and the peripheral compartment C02 is bidirectional, which means that material can flow in both directions. However, it is important to realize that formally C01 is still the source object and C02 still the target object, even though the connection is bidirectional.

**6.3 Area Under the Curve (AUC)**

Continue with the 2-compartment model from the previous paragraph. Now drag a tool object on the desktop. Connect compartment C01 with the integrator tool X01. Double-click the integrator tool and select the variables tab (Var). Mark variable AUC as observed and run a simulation.



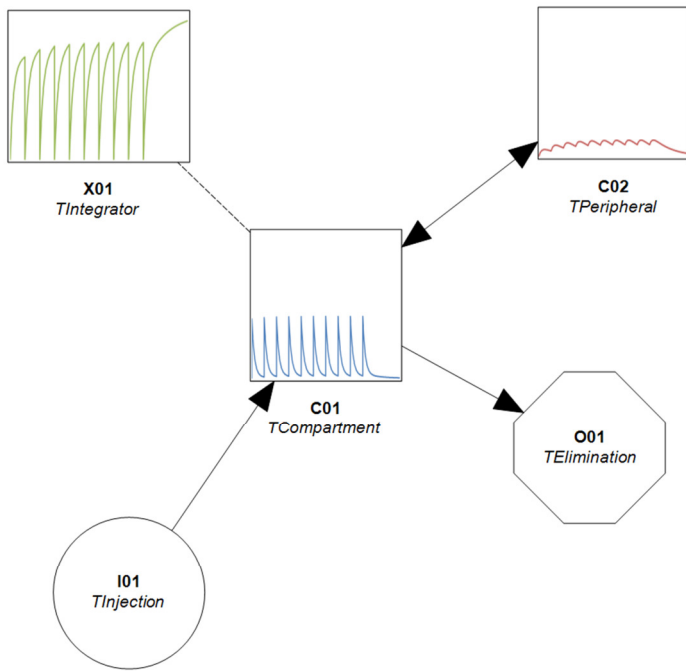

### 6.4 Time Above Level

Continue with the model from the previous paragraph. Select the integrator tool and changes its type to TLevel. Double click the level tool and select the variables tab (Var). Enter a value of 10 mg/L for the LEVEL variable and uncheck its observed status. Next check the observed status of the RTAL variable (relative time above level).

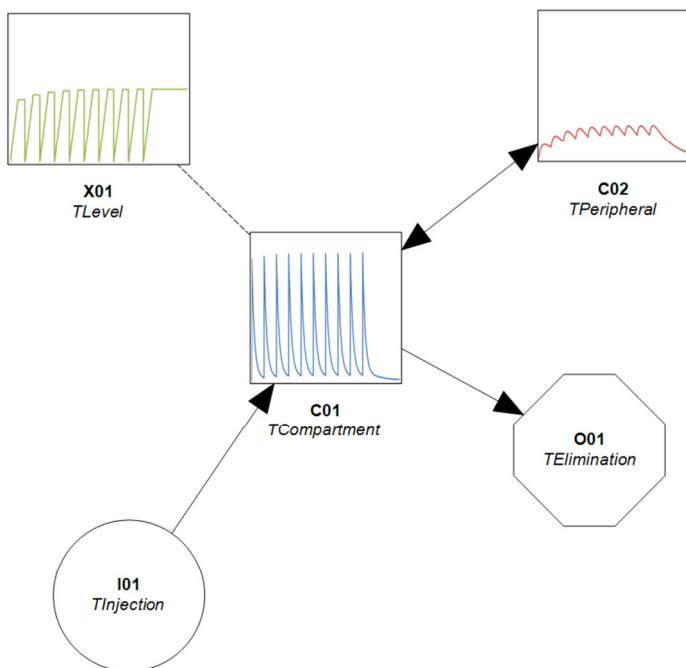

The level tool is typically used for calculating the time above MIC ( $t_{>mic}$ ) of antibiotic drugs. Note that the integrator en level objects are connected with a dashed line with no arrows. This signals the absence of material flow and causality.

6.5 Effect

Continue with the model from the previous paragraph. Now drag an effect object on the desktop. Connect peripheral compartment C02 with effect object E01. Double-click the effect object and select the variables tab (Var). Mark variable E as observed and run a simulation.

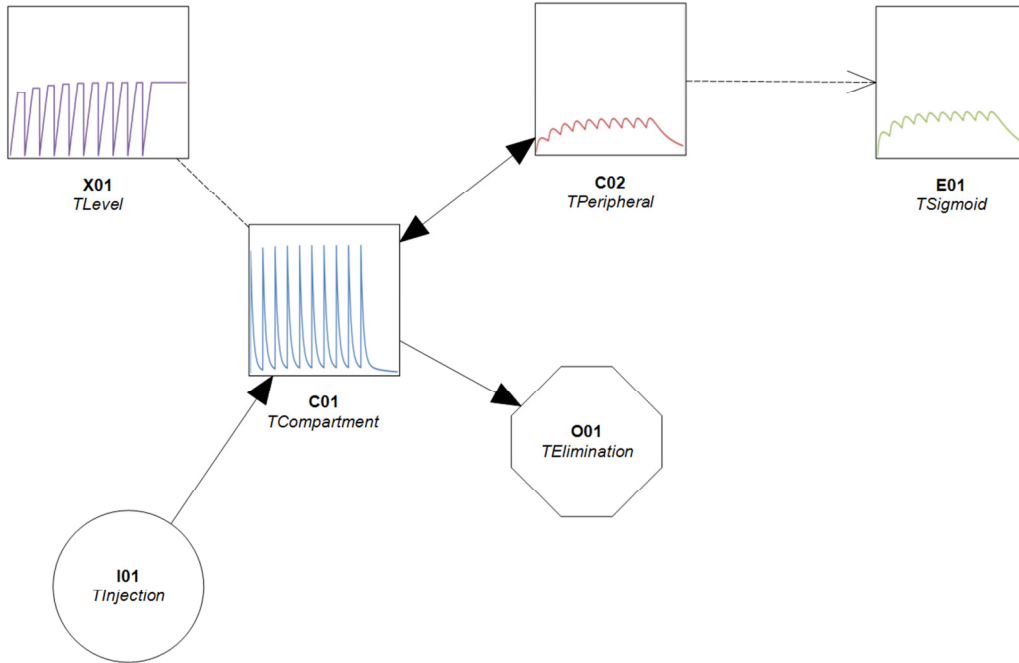

Double-click the effect object again and select the parameter tab (Par). Enter a value of 1 mg/L for the EC50 parameter and run a simulation again. Note how the effect levels have increased.

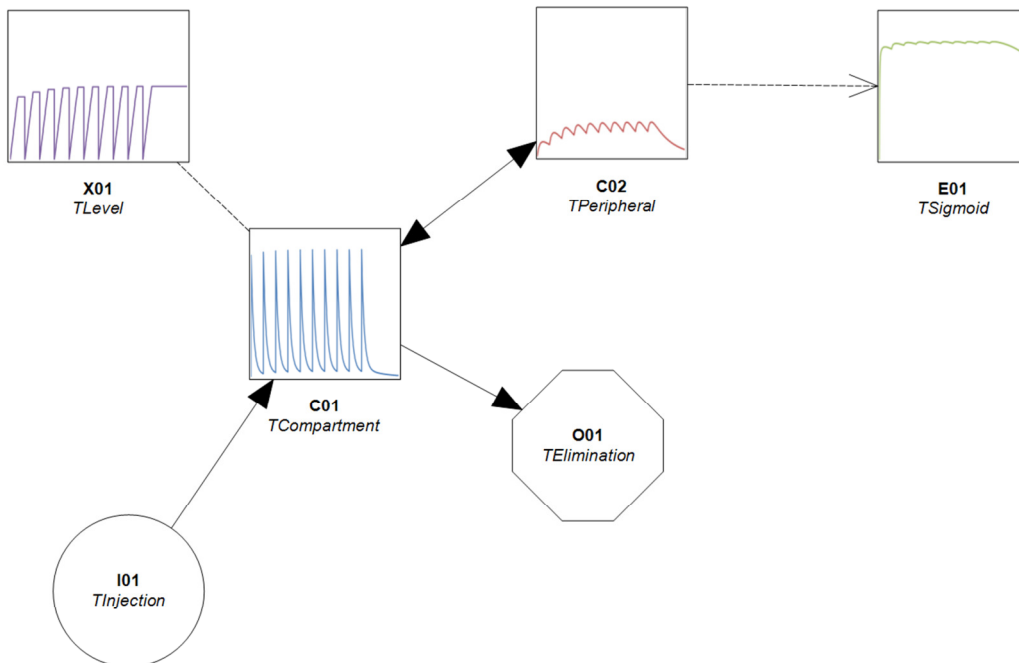

Note that the effect object is connected using a dashed line (no material flow). But the arrow indicates a causal relationship between the source object (C02) and effect (E01).

## 7 RESULTS VIEWER

### 7.1 Microsoft Excel Compatible Workbook

The results tab of Edsim++ is in fact a fully featured spreadsheet that is 100% compatible with Microsoft Excel.

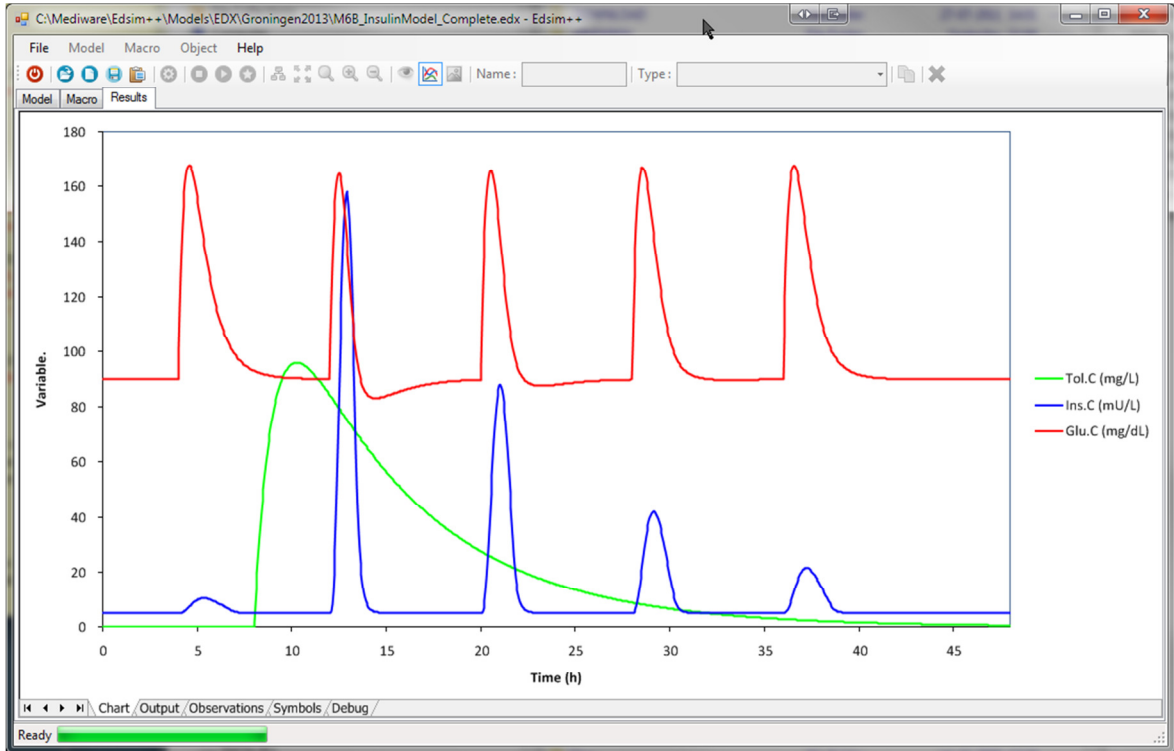

The screenshot shows the 'Results' tab in Edsim++ displaying a spreadsheet table of simulation output. The table has columns for Index, Type, Sys.Tsim, Tol.C, Ins.C, and Glu.C. The data is as follows:

Index	Type	Sys.Tsim (h)	Tol.C (mg/L)	Ins.C (mU/L)	Glu.C (mg/dL)
5	0 Norm	0	0	5	90
6	1 Norm	0.048	0	5	90
7	2 Norm	0.096	0	5	90
8	3 Norm	0.144	0	5	90
9	4 Norm	0.192	0	5	90
10	5 Norm	0.24	0	5	90
11	6 Norm	0.288	0	5	90
12	7 Norm	0.336	0	5	90
13	8 Norm	0.384	0	5	90
14	9 Norm	0.432	0	5	90
15	10 Norm	0.48	0	5	90
16	11 Norm	0.528	0	5	90
17	12 Norm	0.576	0	5	90
18	13 Norm	0.624	0	5	90
19	14 Norm	0.672	0	5	90
20	15 Norm	0.72	0	5	90
21	16 Norm	0.768	0	5	90
22	17 Norm	0.816	0	5	90
23	18 Norm	0.864	0	5	90
24	19 Norm	0.912	0	5	90
25	20 Norm	0.96	0	5	90
26	21 Norm	1.008	0	5	90
27	22 Norm	1.056	0	5	90

You can do all things in the results viewer that you can also do in regular spreadsheets. You can enter formulas into cells but you can also create embedded charts.

### 7.2 Workbook Designer Mode

You can create a 2nd copy of the results viewer outside the Edsim++ application window by right clicking the spreadsheet. Then select Workbook Designer from the context menu.

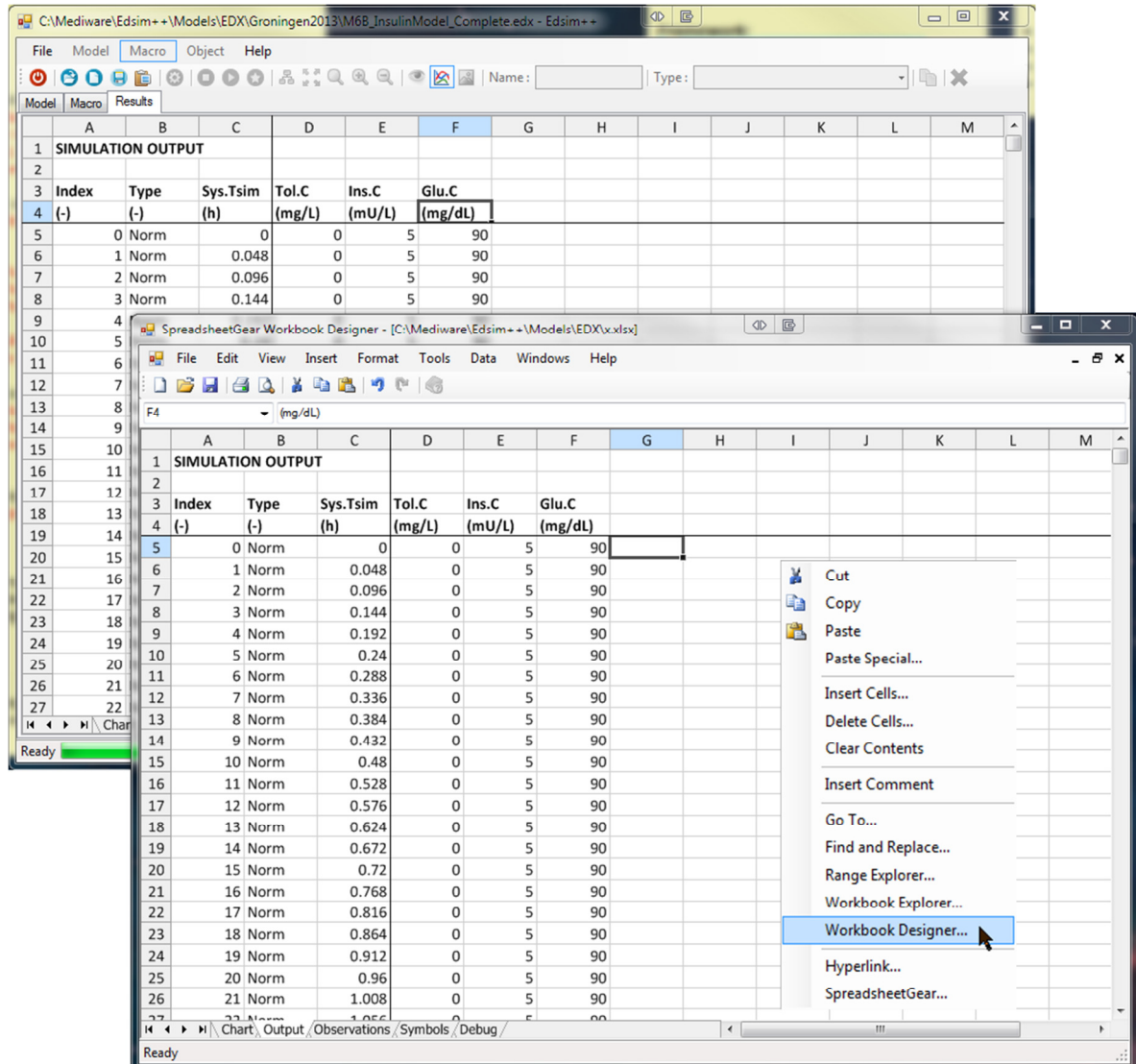

In the external results viewer you have now full access to the spreadsheet menu. Please note that both viewers remain in sync with each other. If you type something in one spreadsheet it will also appear in the other one and vice versa.

### 7.3 Dual Monitor Support

We can use the workbook designer mode of the results viewer for the creation of a dual monitor setup. Move the Edsim++ application window to the left monitor. Select the model tab and maximize the application window. Now move the copy of the results view (designer mode) to the right monitor. Select the chart tab and maximize the window.

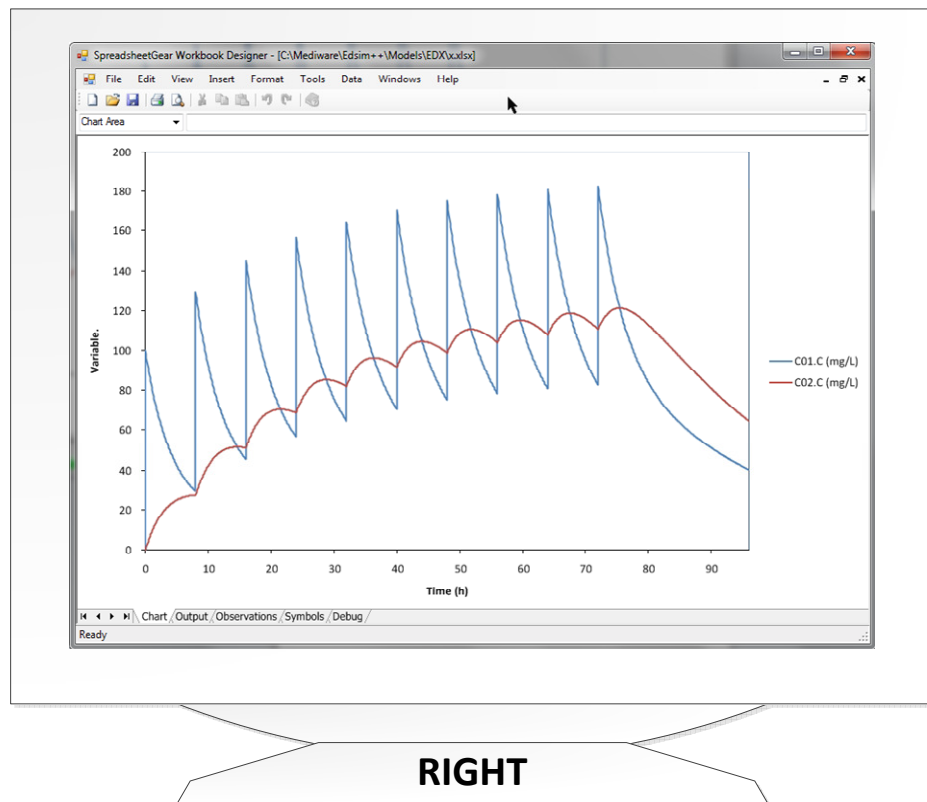
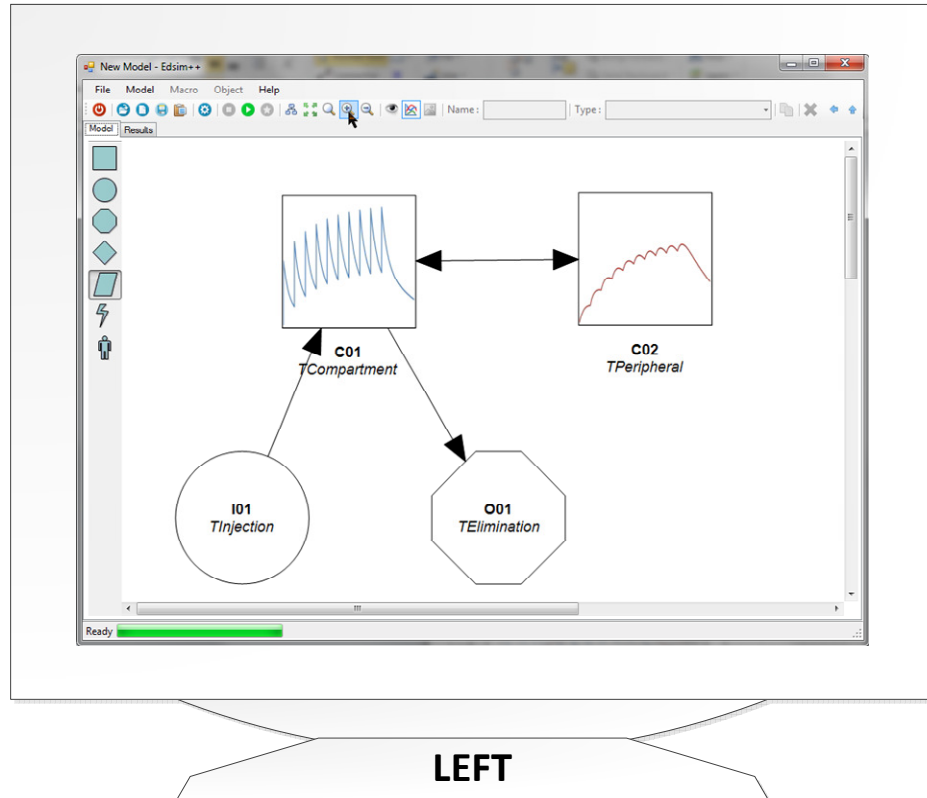

The advantage of this dual monitor setup is that you can now see two chart types simultaneously. On the left monitor you see the model with a spatial chart view while on the right monitor you see the combined chart view.

## 8 MODELS STORAGE

### 8.1 File Formats

Edsim++ supports a number of different file formats for storing models. The following table shows which file formats you can save and/or open with Edsim++ (Ext stands for file extension).

Ext	Save	Open	Description
edx	+	+	Default Edsim++ format (XML). Includes layout and graphics.
xml	+	+	Bare model format (XML). Like edx but without layout and graphics.
cs	+	+	Source code model format (C#). Same data as xml format.
dll	+	+	Binary library model format (.NET). Same data as xml format.
exe	+	-	Binary executable format (.NET). Requires MS Excel to run.
xls(x)	+	-	Excel BIFF (xls) or XML (xlsx) format. Includes image, charts and data.
vdx	+	-	Visio XML format. Only contains a diagram of the model.
wmf	+	-	Windows Meta File format. Only contains a picture of the model.
pdf	+	-	Portable Document Format. Only contains a picture of the model.
png	+	-	Portable Document Format. Only contains an image of the model.

The eds, xml, cs and dll formats can be saved and opened by Edsim++. All other formats can only be saved which makes them essentially one way tickets. We refer to them as export only formats.

Only the Edsim++ native edx format is capable of storing graphical model layout information. If you open xml, cs or dll files, a new layout will be automatically generated.

### 8.2 Format Selection

In the file Save As dialog you can select the file format in the Save as type field. Enter a file name, select the desired format and click Save to store the model on disk. The Open dialog works in the same way.

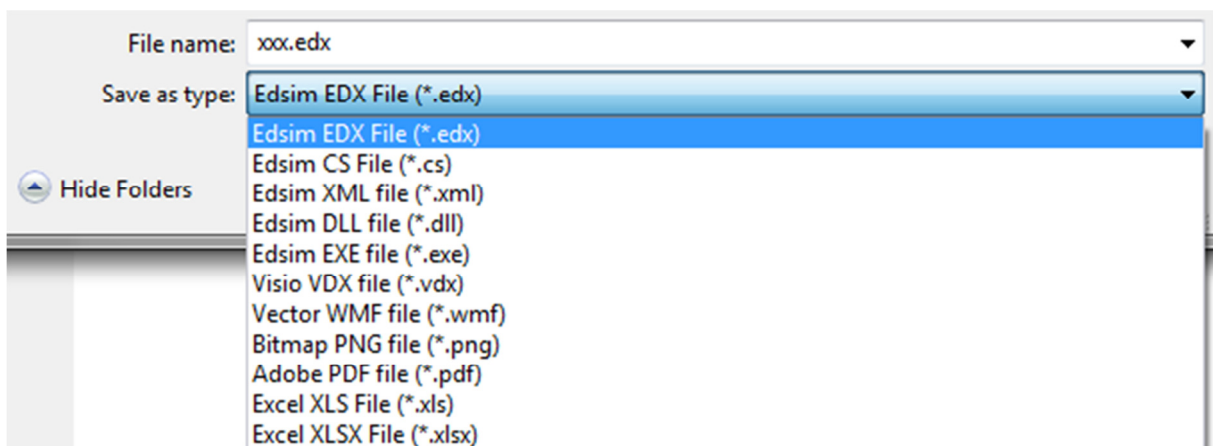

### 8.3 Excel Export

If you save a model in Excel xls(x) format, Excel (or any other default xls file handler) will be automatically launched after the file has been saved to disk.

The screenshot shows a Microsoft Excel spreadsheet titled 'Demo05\_Decoration.xlsx'. The spreadsheet contains a table of simulation output data. The table has 7 columns: Index, Type, Sys.Tsim, C01.C, C02.C, C03.C, and C04.C. The data rows range from 3 to 38. The 'Index' column contains values from 0 to 33. The 'Type' column contains values like 'PreOn', 'PostOn', 'Norm', and 'Max'. The 'Sys.Tsim' column contains values from 0 to 2.88. The concentration columns (C01.C to C04.C) contain numerical values representing concentrations in mg/L.

Index	Type	Sys.Tsim	C01.C	C02.C	C03.C	C04.C
(-)	(-)	(h)	(mg/L)	(mg/L)	(mg/L)	(mg/L)
0	PreOn	0	0	0	0	0
1	PostOn	0	0	0	0	0
2	Norm	0	0	0	0	0
3	Norm	0.096	8.727217	0.085938	0.170768	0.254505
4	Norm	0.192	15.88975	0.320868	0.633395	0.937822
5	Norm	0.288	21.72933	0.674565	1.322642	1.945377
6	Norm	0.384	26.45259	1.121637	2.184153	3.190962
7	Norm	0.48	30.23608	1.640805	3.172818	4.603889
8	Norm	0.576	33.2304	2.214304	4.251375	6.126558
9	Norm	0.672	35.56392	2.827348	5.389205	7.712378
10	Norm	0.768	37.3459	3.46769	6.56131	9.323997
11	Norm	0.864	38.66922	4.125233	7.747429	10.9318
12	Norm	0.96	39.61271	4.791699	8.931288	12.5126
13	Norm	1.056	40.24319	5.460349	10.09996	14.04861
14	Norm	1.152	40.61715	6.125745	11.24334	15.52643
15	Norm	1.248	40.78229	6.783536	12.35363	16.93637
16	Max	1.248	40.78229	6.783536	12.35363	16.93637
17	Norm	1.344	40.77879	7.430292	13.42501	18.27169
18	Norm	1.44	40.64042	8.063347	14.45324	19.52812
19	Norm	1.536	40.39546	8.680673	15.43542	20.70335
20	Norm	1.632	40.06754	9.280776	16.36973	21.79664
21	Norm	1.728	39.67634	9.862599	17.25523	22.80852
22	Norm	1.824	39.23817	10.42545	18.0917	23.74046
23	Norm	1.92	38.76648	10.96892	18.87948	24.59471
24	Norm	2.016	38.27233	11.49286	19.61935	25.37406
25	Norm	2.112	37.76473	11.99729	20.31245	26.08171
26	Norm	2.208	37.25098	12.48241	20.96019	26.72114
27	Norm	2.304	36.73694	12.94852	21.56414	27.29598
28	Norm	2.4	36.22726	13.39603	22.12605	27.80999
29	Norm	2.496	35.72558	13.82541	22.64774	28.2669
30	Norm	2.592	35.23469	14.23718	23.13106	28.67046
31	Norm	2.688	34.75669	14.63191	23.57793	29.02431
32	Norm	2.784	34.2931	15.01017	23.99022	29.33199
33	Norm	2.88	33.84498	15.37257	24.3698	29.59694



## 9 SPECIAL SIMULATIONS

### 9.1 Variable Error

Open the model Demo.edx. Uncheck the Observed box of the concentrations in the peripheral compartments. Now enter the following assay error for the plasma concentration.

VARIABLES		Assay Error			
Name	Weight	sd0	sd1 . C	sd2 . C <sup>2</sup>	
C01.A	OLS_R	0	0	0	
C01.C	OLS_R	10	0.1	0	
C01.Cu	OLS_R	0	0	0	

This is equivalent to the so called constant and proportional error model. The sd0 value can be regarded as the limit of detection (LOD of 10 mg/L) and sd1 has a relative error (10%). In the main menu select Model>Run>Variable Error.

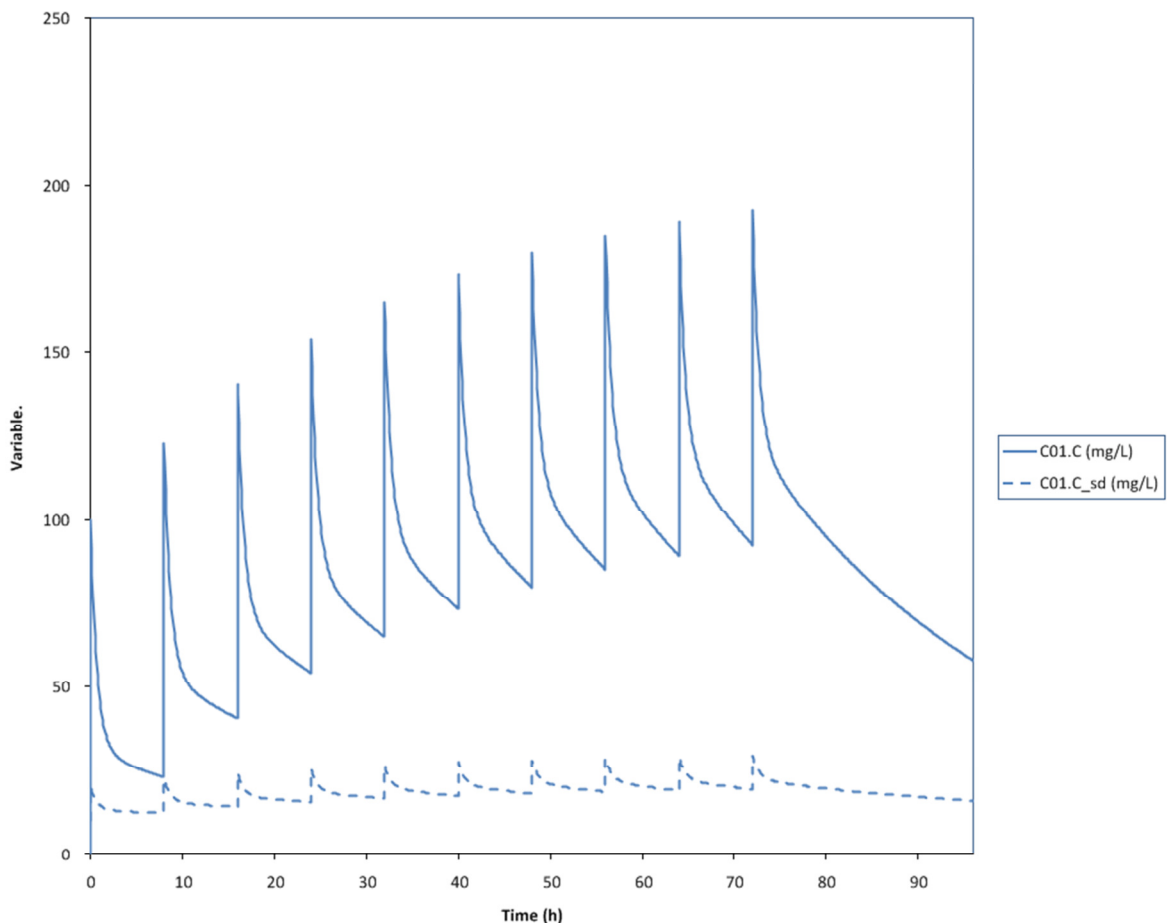

The error will be displayed as a dashed line having the same color as the associated variable. This will only work for observed variables with a defined assay error. A user defined error cannot be used for this purpose.



9.2 Parameter Sensitivity

Now in the same model check the Fit box of the O01.k and C01.V parameters. In the main menu select Model>Run>Parameter Sensitivity.

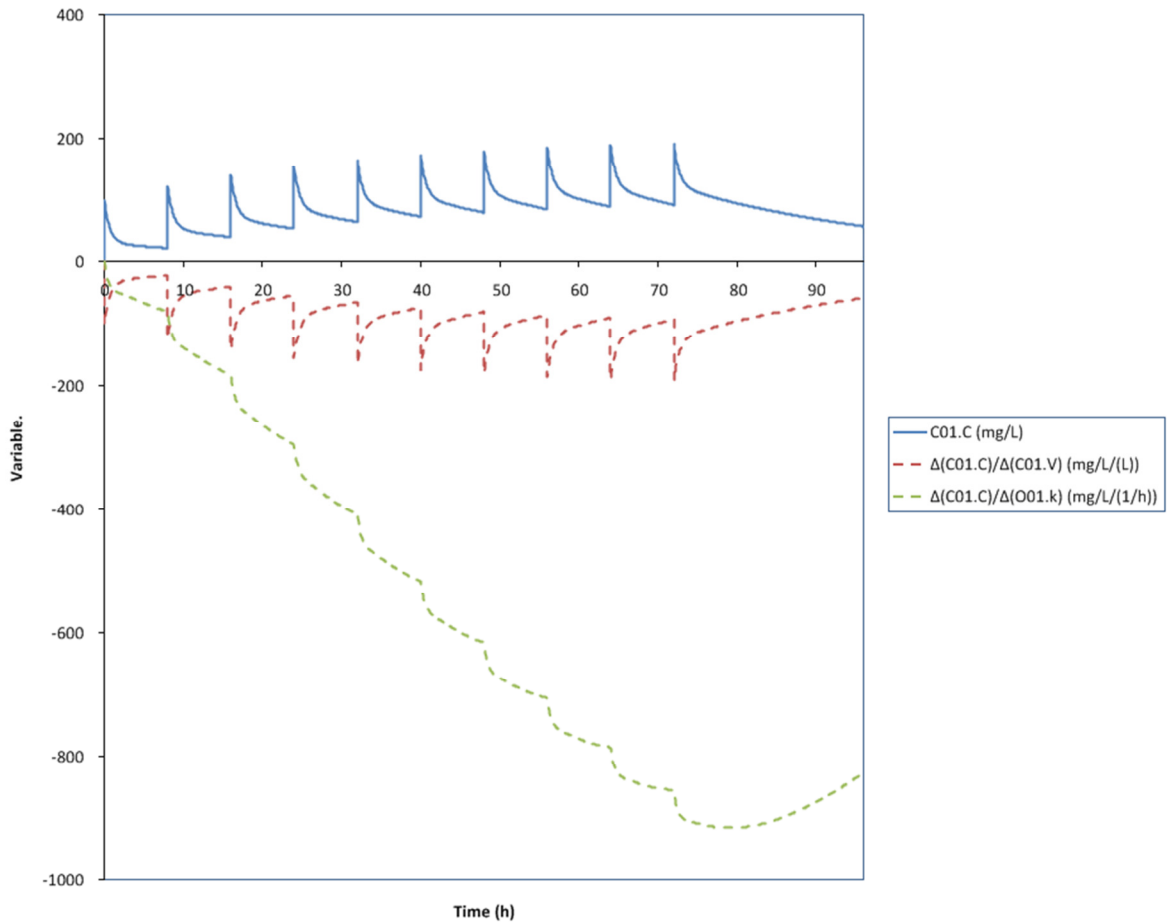

You will see the curve of the observed variable together with the partial derivatives of the parameters that were marked as fitted. In this example the derivatives are negative. E.g. if the volume of distribution V increases, the concentration C will decrease. Also if the elimination rate k increases, the concentration C will also decrease.

9.2.1 Confidence Interval

Open the model MwPharm\Patients\Test-E\gentamicin\_C1.edx. Check the Fit box of the RE.k and C01.V parameters. Fit the model by clicking the fit button . Go to the correlations tab and uncheck the All box.

**CORRELATIONS** All  Pop

	Value	SE	C01.V	RE.k	Unit
C01.V	0.190 ± 0.0431		1		L/kgLbmc
RE.k	0.00136 ± 0.000231		-0.882083	1	1/h/(mL/min/1.73m <sup>2</sup> )

The estimated parameter value, error and correlation are all used for calculating the 95% confidence interval of the plasma concentration. These value can also be entered manually without fitting.

In the main menu select Model>Run>Confidence Interval in order to display the 95% confidence interval of the plasma concentration.

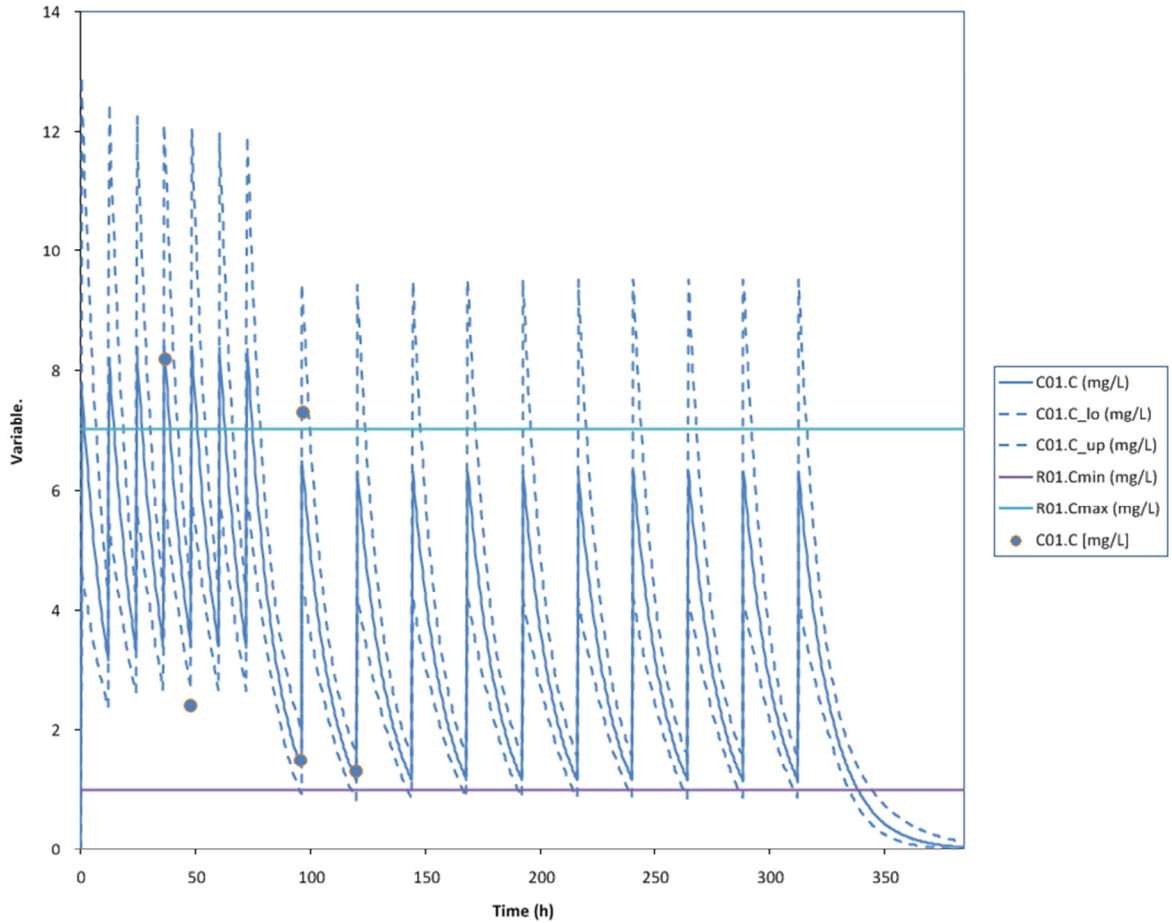

## 10 FITTING MODELS TO OBSERVATIONS

### 10.1 Building a model

Create a simple two compartment model as displayed in the picture below.

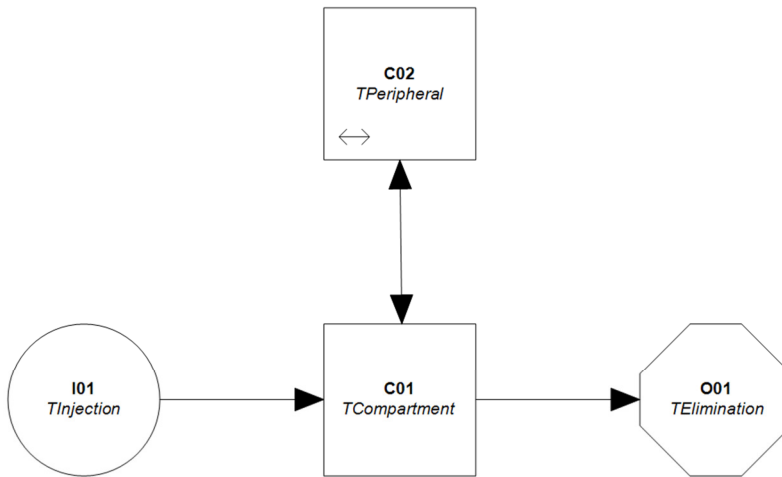

Double-click the injection object (I01) and select the object tab (Obj). Change the number of doses from 10 to 1. Now select the peripheral compartment (C02) and the variables tab (Var). Uncheck the observed box (Obs) for the peripheral concentration (C02.C).

### 10.2 Adding Observations

Now select the central compartment (C01) and the observations tab (Obj). Select the plasma concentration (C01.C) as the variable and enter the following data.

OBSERVATIONS		All <input checked="" type="checkbox"/>
Time (h)	C01.C mg/L	
0.167	2.99	
0.333	4.82	
0.667	2.86	
1	2.23	
1.5	1.65	
2	1.33	
3	1.05	
4	0.945	
6	0.679	
8	0.619	
12	0.462	
24	0.336	
48	0.178	
72	0.084	

10.3 Selecting Parameters

Now select the parameters tab (Par) and check the All box. Check the Fit box of the C01.V, O01.k, C02.kxy and C02.kyx parameters. Leave all the parameters at their default value, except for the volume of distribution C01.V (set to 10 L).

PARAMETERS				All <input checked="" type="checkbox"/>	Pop <input type="checkbox"/>			
Name	Value	SE	Unit	Fit	Bayes	Log		
C01.fu	1.000 ±	0.0000	-	<input type="checkbox"/>	<input type="checkbox"/>	<input checked="" type="checkbox"/>		
C01.V	10.00 ±	0.000	L	<input checked="" type="checkbox"/>	<input type="checkbox"/>	<input checked="" type="checkbox"/>		
C02.fu	1.000 ±	0.0000	-	<input type="checkbox"/>	<input type="checkbox"/>	<input checked="" type="checkbox"/>		
C02.kxy	0.1000 ±	0.00000	1/h	<input checked="" type="checkbox"/>	<input type="checkbox"/>	<input checked="" type="checkbox"/>		
C02.kyx	0.1000 ±	0.00000	1/h	<input checked="" type="checkbox"/>	<input type="checkbox"/>	<input checked="" type="checkbox"/>		
O01.k	0.1000 ±	0.00000	1/h	<input checked="" type="checkbox"/>	<input type="checkbox"/>	<input checked="" type="checkbox"/>		
C02.CL	1.00 ±	0.000	L/h	<input type="checkbox"/>	<input type="checkbox"/>	<input type="checkbox"/>		
C02.txy	6.93 ±	0.000	h	<input type="checkbox"/>	<input type="checkbox"/>	<input type="checkbox"/>		
C02.tyx	6.93 ±	0.000	h	<input type="checkbox"/>	<input type="checkbox"/>	<input type="checkbox"/>		
C02.V	10.00 ±	0.000	L	<input type="checkbox"/>	<input type="checkbox"/>	<input type="checkbox"/>		
O01.CL	1.00 ±	0.000	L/h	<input type="checkbox"/>	<input type="checkbox"/>	<input type="checkbox"/>		
O01.th	6.93 ±	0.000	h	<input type="checkbox"/>	<input type="checkbox"/>	<input type="checkbox"/>		

10.4 Adjust Settings

Select the Fit tab and change the fit method to Simplex.

FITTING	
Bayes	<input type="checkbox"/>
Correlated Bayes	<input type="checkbox"/>
Method	Simplex
Stop criterion	1.00E-06
Max iterations	0
Output iterations	1
Parameter factor	10

10.5 Pre-Simulation.

It is always a good idea to perform a simulation before starting a fit. By doing this we get a good impression whether the fit has any chance of succeeding. If the curve of the initial parameter estimates deviates a lot from the observations the fit may fail.

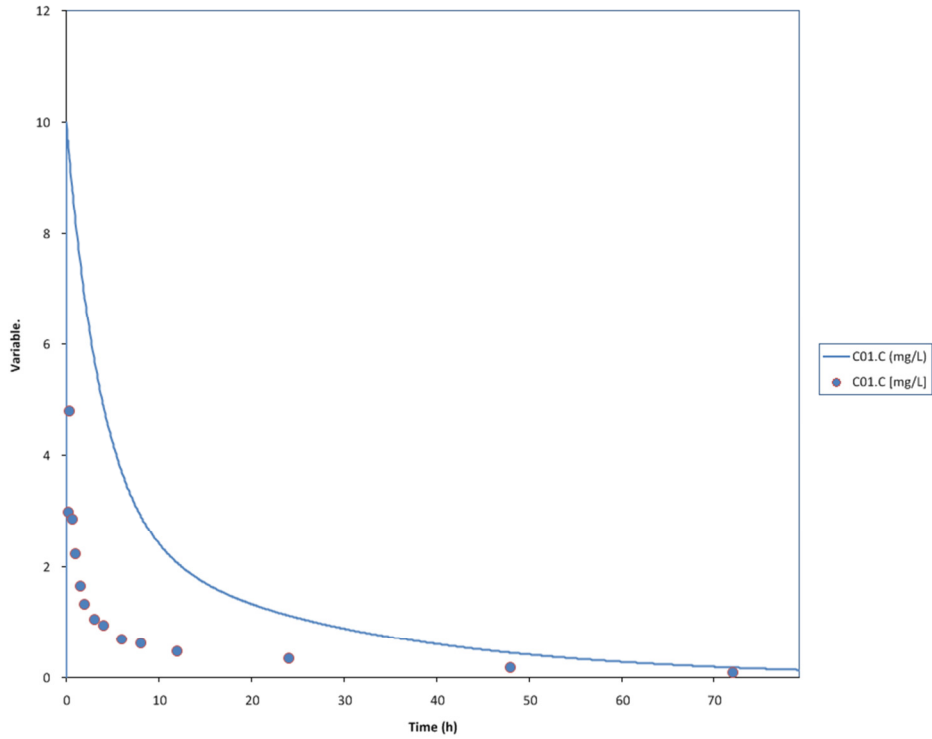

### 10.6 Fitting

Click the fit button ( ) and watch how the fitting algorithm tries to squeeze the curve through the data points.

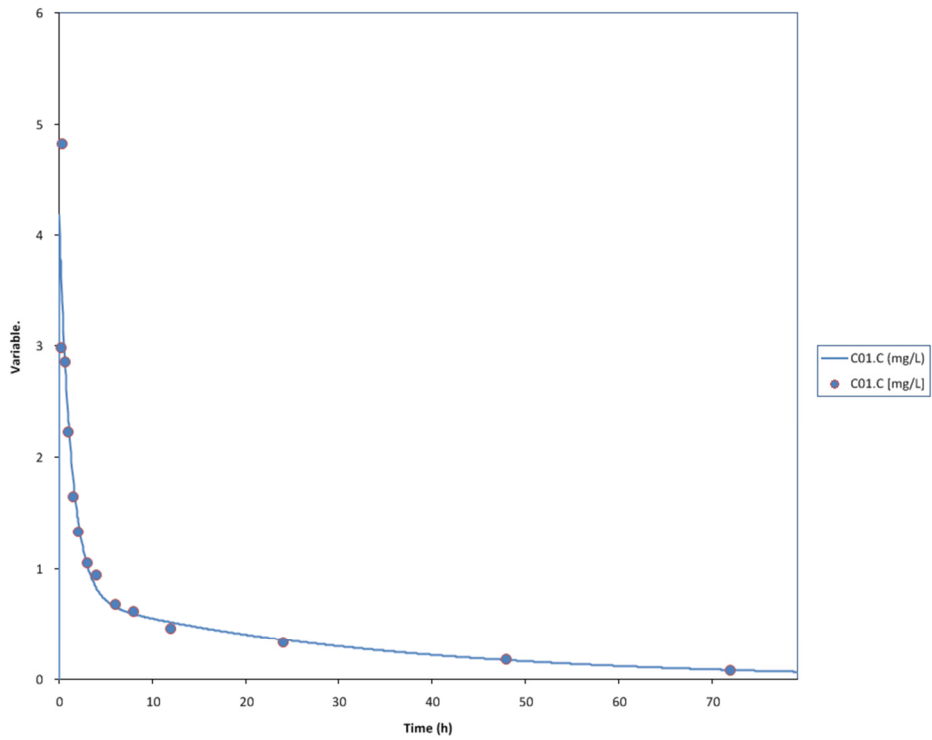

### 10.7 Fit Report

Click on the Fit tab of the Results area to view a detailed fitting report.

FIT OUTPUT									
<b>SETTINGS</b>									
Bayes	No								
Correlated Bayes	No								
Source	DataHalo_IN_C2								
Algorithm	Simplex								
Stop Criterion	1.0E-06								
<b>PERFORMANCE</b>									
Nitr	123								
Nsim	212								
Time (msec)	1403								
<b>DIMENSIONS</b>									
Nobs	14								
Npar	4								
Df	10								
<b>QUALITY</b>									
RMS	0.152727453								
RR	0.986154971								
Akaike	-17.96353568								
<b>RESIDUALS</b>									
USS	0.23325675								
WSS	0.23325675								
ESS	0.23325675								
PSS	0								
OSS	0.23325675								
<b>STATISTICS</b>									
SW	14								
SY	-1.633484305								
SYY	17.03828007								
<b>VARIABLES</b>									
Var	Unit	Weight	LogDist						
C01.C	mg/L	OLS_R	Yes						
<b>PARAMETERS</b>									
Parm	Unit	Type	LogDist	Pop	Ini	Fit	se	cv(%)	
C01.V	L	Fitted	Yes		10.00	23.92	2.63	11.00	
C01.fu	-	Fixed	Yes		1.000				
C02.kyx	1/h	Fitted	Yes		0.1000	0.1595	0.0275	17.25	
C02.kxy	1/h	Fitted	Yes		0.1000	0.4836	0.0984	20.35	
C02.fu	-	Fixed	Yes		1.000				
O01.k	1/h	Fitted	Yes		0.1000	0.1442	0.0163	11.30	
<b>CORRELATIONS</b>									
Parm1	Parm2	Corr	Covar						
C01.V	C02.kxy	-0.75154	-0.194685						
C01.V	C02.kyx	-0.224109	-0.016228						
C01.V	O01.k	-0.895287	-0.038399						
C02.kxy	C02.kyx	0.696237	0.001886						
C02.kxy	O01.k	0.670499	0.001076						
C02.kyx	O01.k	0.160873	7.21E-05						
<b>OBSERVATIONS</b>									
Var	Unit	Time (h)	Obs	Est	Res	Sdev	Weight		
C01.C	mg/L	0.17	2.99	3.77	-0.78	2.99	1		
C01.C	mg/L	0.33	4.82	3.41	1.41	4.82	1		
C01.C	mg/L	0.67	2.86	2.80	0.06	2.86	1		
C01.C	mg/L	1.00	2.23	2.33	-0.10	2.23	1		
C01.C	mg/L	1.50	1.65	1.81	-0.16	1.65	1		
C01.C	mg/L	2.00	1.33	1.46	-0.13	1.33	1		
C01.C	mg/L	3.00	1.05	1.03	0.02	1.05	1		
C01.C	mg/L	4.00	0.95	0.82	0.12	0.95	1		
C01.C	mg/L	6.00	0.68	0.66	0.02	0.68	1		
C01.C	mg/L	8.00	0.62	0.59	0.03	0.62	1		
C01.C	mg/L	12.00	0.46	0.52	-0.05	0.46	1		
C01.C	mg/L	24.00	0.34	0.36	-0.02	0.34	1		
C01.C	mg/L	48.00	0.18	0.17	0.01	0.18	1		
C01.C	mg/L	72.00	0.08	0.08	0.00	0.08	1		

**10.8 Scaling and Weighting**

By default pharmacokinetic parameters and variables are assumed to be log-normal distributed (Log box checked), which means they are log-transformed during fitting. This means that these parameters and variables cannot have a negative value. In contrast, pharmacodynamics parameters and variables are assumed to have a linear normal distribution (Log box unchecked). Normal and log-normal distributed parameters and variables can be freely mixed during a fit.

For a variable the different observation weighting methods can be selected:

- OLS\_A : Constant absolute error.
- OLS\_R : Constant relative error.
- WLS\_O : Variable assay or user error based on observed values.
- WLS\_E : Variable assay or user error based on estimated values.

Here OLS stands for ordinary least squares (OLS) and WLS for weighted least square.

# 11 PARAMETER CONVERSION

## 11.1 Test Model

Create the following test model.

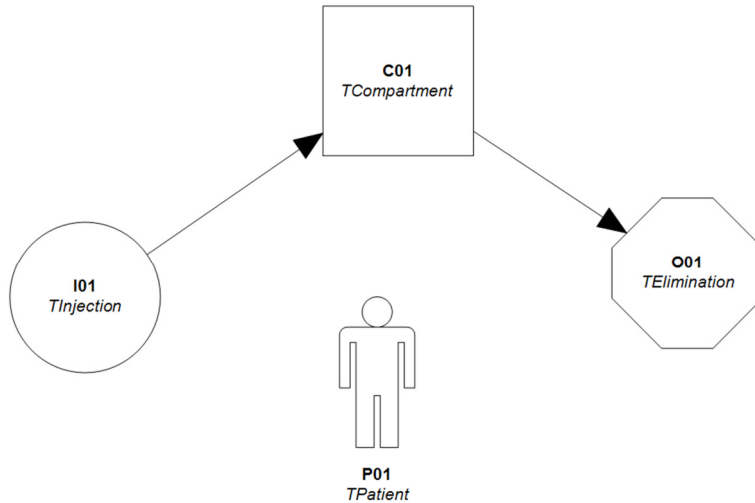

Open the properties window and go to the options tab (Opt). Select object O01 and set the O01.Mode option to Clearance.

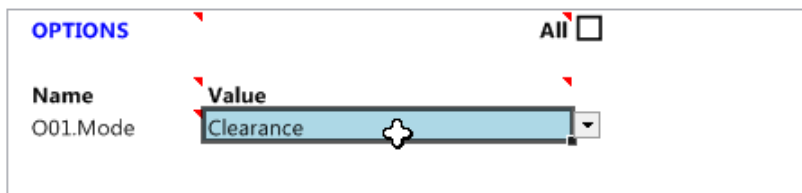

Now go to the parameters tab (Par) and check the All box. Increase the properties window so that all parameter fields are visible. Select as scaler for parameter C01.V the variable P01.Bw using format 2. Select as scaler for parameter C01.CL the variable P01.Bsa using format 2. Enter 10.0 for C01.V and 2.0 for C01.CL. Check the Pop box and enter the same values. Uncheck the Pop box. Your screen should now look like this:

Name	Value	SE	Unit	Fit	Bayes	Log	Scaler	Expo	Format
C01.fu	1.000 ± 0.0000	0.0000	-	<input type="checkbox"/>	<input type="checkbox"/>	<input checked="" type="checkbox"/>		1	3
C01.V	10.00 ± 0.000	0.000	L/70.0kg	<input type="checkbox"/>	<input type="checkbox"/>	<input checked="" type="checkbox"/>	P01.Bw	1	2
O01.CL	2.00 ± 0.000	0.000	L/h/1.85m <sup>2</sup>	<input type="checkbox"/>	<input type="checkbox"/>	<input checked="" type="checkbox"/>	P01.Bsa	1	2
P01.Fd	0.00 ± 0.000	0.000	-	<input type="checkbox"/>	<input type="checkbox"/>	<input checked="" type="checkbox"/>		1	3
O01.k	0.2000 ± 0.00000	0.00000	1/h	<input type="checkbox"/>	<input type="checkbox"/>	<input checked="" type="checkbox"/>			
O01.th	3.47 ± 0.000	0.000	h	<input type="checkbox"/>	<input type="checkbox"/>	<input checked="" type="checkbox"/>			

Calculations:

$$\begin{aligned}
 V &= 10 \text{ (L/70 kg)} * 70 \text{ (kg)} = 10 \text{ (L)} \\
 CL &= 2 \text{ (L/h/1.85m}^2\text{)} * 1.85 \text{ (m}^2\text{)} = 2 \text{ (L/h)} \\
 k &= CL / V = 2 \text{ (L/h)} / 10 \text{ (L)} = 0.2 \text{ (1/h)} \\
 th &= \text{Ln}(2) / k = \text{Ln}(2) / 0.2 \text{ (1/h)} = 3.47 \text{ (h)}
 \end{aligned}$$



11.2 Unit Conversion

Now change the unit of clearance O01.CL from L/h to mL/min.

PARAMETERS		All <input checked="" type="checkbox"/>	Pop <input type="checkbox"/>								
Name	Value	SE	Unit	Fit	Bayes	Log	Scaler	Expo	Format		
C01.fu	1.000 ±	0.00000	-	<input type="checkbox"/>	<input type="checkbox"/>	<input checked="" type="checkbox"/>					
C01.V	10.00 ±	0.000	L/70.0kg	<input type="checkbox"/>	<input type="checkbox"/>	<input checked="" type="checkbox"/>					
O01.CL	33.3 ±	0.00	mL/min/1.85m <sup>2</sup>	<input type="checkbox"/>	<input type="checkbox"/>	<input checked="" type="checkbox"/>	P01.Bw	1	2		
P01.Fd	0.00 ±	0.0000	-	<input type="checkbox"/>	<input type="checkbox"/>	<input checked="" type="checkbox"/>	P01.Bsa	1	2		
O01.k	0.2000 ±	0.00000	1/h	<input type="checkbox"/>	<input type="checkbox"/>	<input checked="" type="checkbox"/>		1	3		
O01.th	3.47 ±	0.000	h	<input type="checkbox"/>	<input type="checkbox"/>	<input checked="" type="checkbox"/>					

Now the value for the clearance is converted from 2.00 L/h/1.85m<sup>2</sup> to 33.3 mL/min/1.85m<sup>2</sup>. Change the unit back again to L/h. Now change the display format for clearance from 2 to 0.

PARAMETERS		All <input checked="" type="checkbox"/>	Pop <input type="checkbox"/>								
Name	Value	SE	Unit	Fit	Bayes	Log	Scaler	Expo	Format		
C01.fu	1.000 ±	0.00000	-	<input type="checkbox"/>	<input type="checkbox"/>	<input checked="" type="checkbox"/>					
C01.V	10.00 ±	0.000	L/70.0kg	<input type="checkbox"/>	<input type="checkbox"/>	<input checked="" type="checkbox"/>					
O01.CL	1.08 ±	0.000	L/h/m <sup>2</sup>	<input type="checkbox"/>	<input type="checkbox"/>	<input checked="" type="checkbox"/>	P01.Bw	1	0		
P01.Fd	0.00 ±	0.0000	-	<input type="checkbox"/>	<input type="checkbox"/>	<input checked="" type="checkbox"/>	P01.Bsa	1	3		
O01.k	0.2000 ±	0.00000	1/h	<input type="checkbox"/>	<input type="checkbox"/>	<input checked="" type="checkbox"/>		1			
O01.th	3.47 ±	0.000	h	<input type="checkbox"/>	<input type="checkbox"/>	<input checked="" type="checkbox"/>					

Now the value for the clearance is converted from 2.00 L/h/1.85m<sup>2</sup> to 1.08 L/h/m<sup>2</sup>. Change the format back again to 2.

11.3 Scaler Conversion

Now change the scaler variable of the clearance parameter from body surface area to body weight

PARAMETERS		All <input checked="" type="checkbox"/>	Pop <input type="checkbox"/>								
Name	Value	SE	Unit	Fit	Bayes	Log	Scaler	Expo	Format		
C01.fu	1.000 ±	0.00000	-	<input type="checkbox"/>	<input type="checkbox"/>	<input checked="" type="checkbox"/>					
C01.V	10.00 ±	0.000	L/70.0kg	<input type="checkbox"/>	<input type="checkbox"/>	<input checked="" type="checkbox"/>	P01.Bw	1	2		
O01.CL	2.00 ±	0.000	L/h/70.0kg	<input type="checkbox"/>	<input type="checkbox"/>	<input checked="" type="checkbox"/>	P01.Bw	1	2		
P01.Fd	0.00 ±	0.0000	-	<input type="checkbox"/>	<input type="checkbox"/>	<input checked="" type="checkbox"/>		1	3		
O01.k	0.2000 ±	0.00000	1/h	<input type="checkbox"/>	<input type="checkbox"/>	<input checked="" type="checkbox"/>					
O01.th	3.47 ±	0.000	h	<input type="checkbox"/>	<input type="checkbox"/>	<input checked="" type="checkbox"/>					

The value of the clearance remains at 2.00 because we are dealing with a population patient. Change the scaler for clearance back again to body surface area. Go to the patient variables and enter a height of 150 cm and a body weight of 50 kg.

VARIABLES		All <input type="checkbox"/>	Pop <input type="checkbox"/>								
Name	Value	Unit	Obs	Axis	Color	Peak	NoInt	Log			
P01.Age	55.0	year	<input type="checkbox"/>	<input type="checkbox"/>	<input type="checkbox"/>	<input type="checkbox"/>	<input type="checkbox"/>	<input checked="" type="checkbox"/>			
P01.Bh	150	cm	<input type="checkbox"/>	<input type="checkbox"/>	<input type="checkbox"/>	<input type="checkbox"/>	<input type="checkbox"/>	<input checked="" type="checkbox"/>			
P01.Bw	50.0	kg	<input type="checkbox"/>	<input type="checkbox"/>	<input type="checkbox"/>	<input type="checkbox"/>	<input type="checkbox"/>	<input checked="" type="checkbox"/>			

Go back to the parameters tab (Par).

PARAMETERS		All <input checked="" type="checkbox"/>	Pop <input type="checkbox"/>	Allometry					
Name	Value	SE	Unit	Fit	Bayes	Log	Scaler	Expo	Format
C01.fu	1.000 ± 0.0000	0.0000	-	<input type="checkbox"/>	<input type="checkbox"/>	<input checked="" type="checkbox"/>			
C01.V	10.00 ± 0.000	0.000	L/70.0kg	<input type="checkbox"/>	<input type="checkbox"/>	<input checked="" type="checkbox"/>	P01.Bw	1	2
O01.CL	2.00 ± 0.000	0.000	L/h/1.85m <sup>2</sup>	<input type="checkbox"/>	<input type="checkbox"/>	<input checked="" type="checkbox"/>	P01.Bsa	1	2
P01.Fd	0.00 ± 0.000	0.000	-	<input type="checkbox"/>	<input type="checkbox"/>	<input checked="" type="checkbox"/>			
O01.k	0.2170 ± 0.00000	0.00000	1/h	<input type="checkbox"/>	<input type="checkbox"/>	<input checked="" type="checkbox"/>			
O01.th	3.19 ± 0.000	0.000	h	<input type="checkbox"/>	<input type="checkbox"/>	<input checked="" type="checkbox"/>			

Note how the elimination rate has increased and half-life has decreased. This is because the parameters are now scaled using the current patient. If you check the Pop box you will see the old values again. This is because population parameters are always scaled using the population patient, which we did not change at this time. Please uncheck the Pop box again.

Calculations:

$$V = 10 \text{ (L/70 kg)} * 50 \text{ (kg)} = 7.14 \text{ (L)}$$

$$CL = 2 \text{ (L/h/1.85m}^2\text{)} * 1.43 \text{ (m}^2\text{)} = 1.55 \text{ (L/h)}$$

$$k = CL / V = 1.55 \text{ (L/h)} / 7.14 \text{ (L)} = 0.217 \text{ (1/h)}$$

$$th = \text{Ln}(2) / k = \text{Ln}(2) / 0.217 \text{ (1/h)} = 3.19 \text{ (h)}$$

Now change the scaler variable of the clearance parameter from body surface area to body weight again.

PARAMETERS		All <input checked="" type="checkbox"/>	Pop <input type="checkbox"/>	Allometry					
Name	Value	SE	Unit	Fit	Bayes	Log	Scaler	Expo	Format
C01.fu	1.000 ± 0.0000	0.0000	-	<input type="checkbox"/>	<input type="checkbox"/>	<input checked="" type="checkbox"/>			
C01.V	10.00 ± 0.000	0.000	L/70.0kg	<input type="checkbox"/>	<input type="checkbox"/>	<input checked="" type="checkbox"/>	P01.Bw	1	2
O01.CL	2.17 ± 0.000	0.000	L/h/70.0kg	<input type="checkbox"/>	<input type="checkbox"/>	<input checked="" type="checkbox"/>	P01.Bw	1	2
P01.Fd	0.00 ± 0.000	0.000	-	<input type="checkbox"/>	<input type="checkbox"/>	<input checked="" type="checkbox"/>			
O01.k	0.2170 ± 0.00000	0.00000	1/h	<input type="checkbox"/>	<input type="checkbox"/>	<input checked="" type="checkbox"/>			
O01.th	3.19 ± 0.000	0.000	h	<input type="checkbox"/>	<input type="checkbox"/>	<input checked="" type="checkbox"/>			

Note how the value for clearance has changed now from 2.00 L/h/1.85m<sup>2</sup> to 2.17 L/h/70kg. For an individual patient Edsim++ wants to keep the denormalized parameters constant. So the half-life must remain 3.19 h, therefore the value of the clearance must be increased for this conversion. Also note the color change of the clearance field. So we also created an individual parameter in this conversion process because the value is specific for this patient.

### 11.4 Mode Conversion

Reset the clearance scaler back again to body surface area. Change the weight and the height of the patient back to population values (70 kg and 175 cm). This will restore the state we started with.

PARAMETERS		All <input checked="" type="checkbox"/>	Pop <input type="checkbox"/>				Allometry		
Name	Value	SE	Unit	Fit	Bayes	Log	Scaler	Expo	Format
C01.fu	1.000	± 0.00000	-	<input type="checkbox"/>	<input type="checkbox"/>	<input checked="" type="checkbox"/>		1	3
C01.V	10.00	± 0.000	L/70.0kg	<input type="checkbox"/>	<input type="checkbox"/>	<input checked="" type="checkbox"/>	P01.Bw	1	2
O01.CL	2.00	± 0.000	L/h/1.85m <sup>2</sup>	<input type="checkbox"/>	<input type="checkbox"/>	<input checked="" type="checkbox"/>	P01.Bsa	1	2
P01.Fd	0.00	± 0.000	-	<input type="checkbox"/>	<input checked="" type="checkbox"/>	<input checked="" type="checkbox"/>		1	3
O01.k	0.2000	± 0.00000	1/h	<input type="checkbox"/>	<input checked="" type="checkbox"/>	<input checked="" type="checkbox"/>			
O01.th	3.47	± 0.000	h	<input type="checkbox"/>	<input type="checkbox"/>	<input checked="" type="checkbox"/>			

No select the elimination object O01 and go to the options tab (Opt). Set the mode to Rate.

OPTIONS		All <input type="checkbox"/>
Name	Value	
O01.Mode	Rate	

Go back to the parameters tab (Par).

PARAMETERS		All <input checked="" type="checkbox"/>	Pop <input type="checkbox"/>				Allometry		
Name	Value	SE	Unit	Fit	Bayes	Log	Scaler	Expo	Format
C01.fu	1.000	± 0.00000	-	<input type="checkbox"/>	<input type="checkbox"/>	<input checked="" type="checkbox"/>		1	3
C01.V	10.00	± 0.000	L/70.0kg	<input type="checkbox"/>	<input type="checkbox"/>	<input checked="" type="checkbox"/>	P01.Bw	1	2
O01.k	0.2000	± 0.00000	1/h	<input type="checkbox"/>	<input checked="" type="checkbox"/>	<input checked="" type="checkbox"/>		1	3
P01.Fd	0.00	± 0.000	-	<input type="checkbox"/>	<input checked="" type="checkbox"/>	<input checked="" type="checkbox"/>		1	3
O01.CL	2.00	± 0.000	L/h	<input type="checkbox"/>	<input type="checkbox"/>	<input checked="" type="checkbox"/>			
O01.th	3.47	± 0.000	h	<input type="checkbox"/>	<input type="checkbox"/>	<input checked="" type="checkbox"/>			

After selecting the Rate mode the elimination rate O01.k is the primary parameter and clearance is derived from this. But the values are still the same. Also note that the scaler variable has been cleared. Now restore mode, scaler and format again (clearance, body surface area and 2) and enter a value of 4.0 for the clearance. This is an individual value now because it differs from the population value as indicated by the yellow field color.

PARAMETERS		All <input checked="" type="checkbox"/>	Pop <input type="checkbox"/>				Allometry		
Name	Value	SE	Unit	Fit	Bayes	Log	Scaler	Expo	Format
C01.fu	1.000	± 0.00000	-	<input type="checkbox"/>	<input type="checkbox"/>	<input checked="" type="checkbox"/>		1	3
C01.V	10.00	± 0.000	L/70.0kg	<input type="checkbox"/>	<input type="checkbox"/>	<input checked="" type="checkbox"/>	P01.Bw	1	2
O01.CL	4.00	± 0.000	L/h/1.85m <sup>2</sup>	<input type="checkbox"/>	<input type="checkbox"/>	<input checked="" type="checkbox"/>	P01.Bsa	1	2
P01.Fd	0.00	± 0.000	-	<input type="checkbox"/>	<input checked="" type="checkbox"/>	<input checked="" type="checkbox"/>		1	3
O01.k	0.4000	± 0.00000	1/h	<input type="checkbox"/>	<input checked="" type="checkbox"/>	<input checked="" type="checkbox"/>			
O01.th	1.73	± 0.000	h	<input type="checkbox"/>	<input type="checkbox"/>	<input checked="" type="checkbox"/>			

Go to the options tab (Opt) and select the rate mode again. Go back to the parameters tab (Par) and look at the result. Again the elimination rate is the primary value again but the values still remain the same.

PARAMETERS		All <input checked="" type="checkbox"/>	Pop <input type="checkbox"/>				Allometry			
Name	Value	SE	Unit	Fit	Bayes	Log	Scaler	Expo	Format	
C01.fu	1.000 ± 0.0000	0.0000	-	<input type="checkbox"/>	<input type="checkbox"/>	<input checked="" type="checkbox"/>			3	
C01.V	10.00 ± 0.000	0.000	L/70.0kg	<input type="checkbox"/>	<input type="checkbox"/>	<input checked="" type="checkbox"/>	P01.Bw	1	2	
O01.k	0.4000 ± 0.00000	0.00000	1/h	<input type="checkbox"/>	<input type="checkbox"/>	<input checked="" type="checkbox"/>		1	3	
P01.Fd	0.00 ± 0.000	0.000	-	<input type="checkbox"/>	<input type="checkbox"/>	<input checked="" type="checkbox"/>		1	3	
O01.CL	4.00 ± 0.000	0.000	L/h	<input type="checkbox"/>	<input type="checkbox"/>	<input checked="" type="checkbox"/>				
O01.th	1.73 ± 0.000	0.000	h	<input type="checkbox"/>	<input type="checkbox"/>	<input checked="" type="checkbox"/>				

Now restore mode, scaler and format again (clearance, body surface area and 2) and enter a height of 150 cm and a body weight of 50 kg for the patient. Look at the parameter tab (Par) for the results.

PARAMETERS		All <input checked="" type="checkbox"/>	Pop <input type="checkbox"/>				Allometry			
Name	Value	SE	Unit	Fit	Bayes	Log	Scaler	Expo	Format	
C01.fu	1.000 ± 0.0000	0.0000	-	<input type="checkbox"/>	<input type="checkbox"/>	<input checked="" type="checkbox"/>		1	3	
C01.V	10.00 ± 0.000	0.000	L/70.0kg	<input type="checkbox"/>	<input type="checkbox"/>	<input checked="" type="checkbox"/>	P01.Bw	1	2	
O01.CL	4.00 ± 0.000	0.000	L/h/1.85m <sup>2</sup>	<input type="checkbox"/>	<input type="checkbox"/>	<input checked="" type="checkbox"/>	P01.Bsa	1	2	
P01.Fd	0.00 ± 0.000	0.000	-	<input type="checkbox"/>	<input type="checkbox"/>	<input checked="" type="checkbox"/>		1	3	
O01.k	0.4341 ± 0.00000	0.00000	1/h	<input type="checkbox"/>	<input type="checkbox"/>	<input checked="" type="checkbox"/>				
O01.th	1.60 ± 0.000	0.000	h	<input type="checkbox"/>	<input type="checkbox"/>	<input checked="" type="checkbox"/>				

Note how the elimination rate has increased and half-life has decreased. This is because the parameters are now scaled using the current patient. If you check the Pop box you will see the old values again. This is because population parameters are always scaled using the population patient, which we did not change at this time. Please uncheck the Pop box again.

Calculations:

$$V = 10 \text{ (L/70 kg)} * 50 \text{ (kg)} = 7.14 \text{ (L)}$$

$$CL = 4 \text{ (L/h/1.85m}^2\text{)} * 1.43 \text{ (m}^2\text{)} = 3.10 \text{ (L/h)}$$

$$k = CL / V = 3.092 \text{ (L/h)} / 7.14 \text{ (L)} = 0.4341 \text{ (1/h)}$$

$$th = \text{Ln}(2) / k = \text{Ln}(2) / 0.217 \text{ (1/h)} = 1.60 \text{ (h)}$$

PARAMETERS		All <input checked="" type="checkbox"/>	Pop <input type="checkbox"/>				Allometry			
Name	Value	SE	Unit	Fit	Bayes	Log	Scaler	Expo	Format	
C01.fu	1.000 ± 0.0000	0.0000	-	<input type="checkbox"/>	<input type="checkbox"/>	<input checked="" type="checkbox"/>			3	
C01.V	10.00 ± 0.000	0.000	L/70.0kg	<input type="checkbox"/>	<input type="checkbox"/>	<input checked="" type="checkbox"/>	P01.Bw	1	2	
O01.k	0.4341 ± 0.00000	0.00000	1/h	<input type="checkbox"/>	<input type="checkbox"/>	<input checked="" type="checkbox"/>		1	3	
P01.Fd	0.00 ± 0.000	0.000	-	<input type="checkbox"/>	<input type="checkbox"/>	<input checked="" type="checkbox"/>		1	3	
O01.CL	3.10 ± 0.000	0.000	L/h	<input type="checkbox"/>	<input type="checkbox"/>	<input checked="" type="checkbox"/>				
O01.th	1.60 ± 0.000	0.000	h	<input type="checkbox"/>	<input type="checkbox"/>	<input checked="" type="checkbox"/>				

Go to the options tab (Opt) and select the rate mode again. Go back to the parameters tab (Par) and look at the result. Again the elimination rate is the primary value again. But note that the clearance has a different value now. That is because it is now displayed as a denormalized value in L/h. However, half-life remained the same again (1.60 h).

**12 EDSIM++ PLUG-INS****12.1 Monte Carlo Simulator****12.2 Dose Calculator**

## 13 PROGRAMMING EDSIM++

### 13.1 Macros

Edsim++ models can also be represented in the C# programming language. We refer to such models as macros. Macros can be created from scratch within the Edsim++ application. There is no need for a separate development environment like Visual Studio. A default macro template is generated when you select New Macro from the File menu.

```
using System;
using System.Linq;
using Mediware.Edsim.ModLib;
using Mediware.Edsim.ModObj;
using Mediware.Edsim.ModWrk;
using Mediware.Edsim.ModSim;
using Mediware.Edsim.ModFit;

namespace Mediware.Edsim.Model
{
    public class TUserModel : TWorkModel
    {
        // Input
        public TInjection I1 = new TInjection();

        // Output
        public TElimination O1 = new TElimination();

        // Compartments
        public TCompartment C1 = new TCompartment();

        // Connect objects
        public override void Connect()
        {
            Link(I1, C1);
            Link(C1, O1);
        }

        // Pre-connect initialization.
        public override void Init()
        {
            I1.AddEvent(100, 0, 0, 8, 10);
        }

        // Post-connect initialization.
        public override void Final()
        {
        }

        // Simulator initialization
        public override void InitSim(SimSet settings)
        {
        }

        // Fitter initialization
        public override void InitFit(FitSet settings)
        {
        }
    }
}
```

The model above is a simple 1-compartment model with an injection input and an elimination output. The injection object defines an event sequence of 10 times 100 mg every 8 hours. You can use this as a starting point when building your own models in C#.

As an alternative, you can also convert an existing model diagram into a macro by selecting Convert to Macro from the Model menu. You can use this feature to learn of complex models can be represented in C#.

## 13.2 Objects

In model diagrams and macros you make use of existing PKPD objects which are part of the Edsim++ PKPD object library. These objects are also programmed in C#. You can create a new object in Edsim++ by selecting New Object from the File menu. You will be presented with an empty object template that can serve as a starting point for your own objects.

```
using Mediware.Edsim.ModLib;

namespace Mediware.Edsim.ModObj
{
    [Description("Edsim++ Object definition template.")]

    public class TMyCompartment : BCompartment
    {
        // Symbol declaration go here

        // Pre-connect initialization.
        public override void Init()
        {
        }

        // Post-connect initialization
        public override void Final()
        {
        }

        // Normal Equations
        public override void CalcNorm()
        {
        }

        // Differential Equations
        public override void CalcDiff()
        {
        }
    }
}
```

You must recompile the PKPD object library when you want to add a new or modified object to it. You must then restart Edsim++ in order to use the updated library. You can view the source code of any existing object in a model diagram by double-clicking it. You then click the Code button in the object tab (Obj). Below you see an example of the code for an injection object.

```
using Mediware.Edsim.ModLib;

namespace Mediware.Edsim.ModObj
{
    /// <summary>
    /// IV bolus injection input class.
    /// </summary>

    [Description("IV bolus injection input class.")]

    public class TInjection : TInput
    {
        /// <summary>
        /// Execute on-event.
        /// </summary>
        public override void EventOn()
        {
            Ay.Value = Ay.Value + Dose.Value;
        }
    }
}
```

Macro and object code is actually beyond the scope of this manual. But you can already learn a lot from converting model diagrams into macros and by viewing the code of existing objects.

## 14 APPENDICES

### 14.1 Edsim++ Error Messages

Library	Exception	Message
ModLib	LinkSourceException	Object A cannot be the source of target object B. Source must be of type: T.
	LinkTargetException	Object A cannot be the target of source object B. Target must be of type: T.
	LinkInCountException	Object A cannot have more than N source(s).
	LinkOutCountException	Object A cannot have more than N target(s).
	UnresolvedSymbolException	Symbol S in object A has not been resolved by any of the connected objects. Objects may be incompatible or links missing.
	InstanceNotAllowedException	Object A is of type T. You are not allowed to create instances of this type because it is marked with the NoInstance attribute.
	OneInstanceAllowedException	Only one object of type T is allowed because it is marked with the OneInstance attribute.
	CircularReferenceException	Parameters P and Q reference each other for sharing (circular reference).
	HiddenFieldException	Hidden field F detected in class C. This is not allowed. Rethink inheritance strategy.
ModWrk	UnknownObjectException	Reference to unknown object A.
	UnknownSymbolException	Reference to unknown symbol S.
NumLib	IterationException	Too many steps in procedure P.
ModSim	UserAbortException	The simulation was aborted by the user.
	SteadyStateAbortException	The simulation was aborted because steady state was reached.
	LevelDetectException	Level detection is enabled without setting a trigger variable
	SmallStepException	Step size of s too small at time t



**14.2 Fitting Methodology**